

#TL100162

INSTALLATION MANUAL

CBK0041/42

APR RS3/TT-RS Catback Exhaust

APR



Notes:

These instructions were written for a North American specification 8Y RS3, but other models like the 8V RS3 and 8S TT-RS are similar.

When disassembling the car, be sure to keep all fasteners so they can be reused. It is recommended that you get some kind of compartmented tray to organize the fasteners, such as a fishing tackle box or several large ice cube trays. Fasteners that are not reused for reinstallation are noted in the instructions. All directions used in this manual (right, left, front, etc.) are based on if you were sitting in the drivers seat of the car.

These instructions assume that you have basic mechanical skills and several varieties of basic hand tools in order to install the kit. If you have any questions about the install, feel free to contact your APR representative.



WWW.GOAPR.COM

4800 US HWY 280 West Opelika Alabama 36801

TL100162

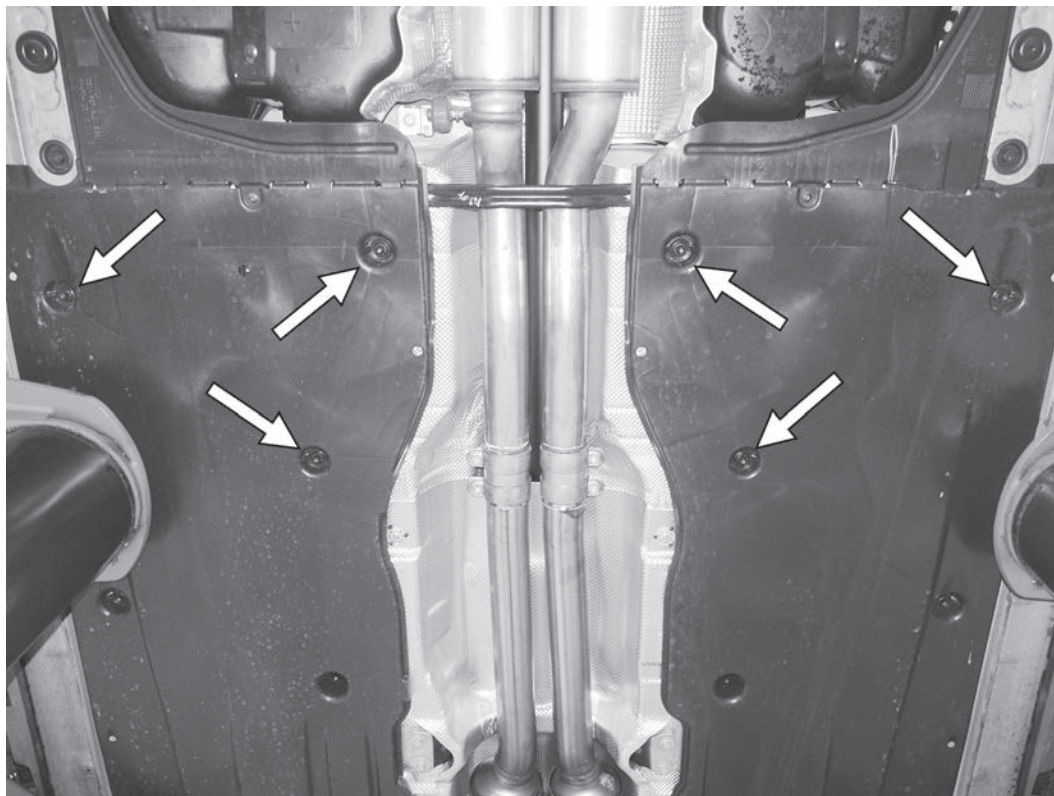

1) Support the car on a lift or jack-stands. Remove the six 10mm from the rear fasteners on both side underbody panels.

APR

2) Slightly lower both side underbody panels, and remove the four 13mm nuts from the rear crossbrace. Remove the crossbrace from the car.

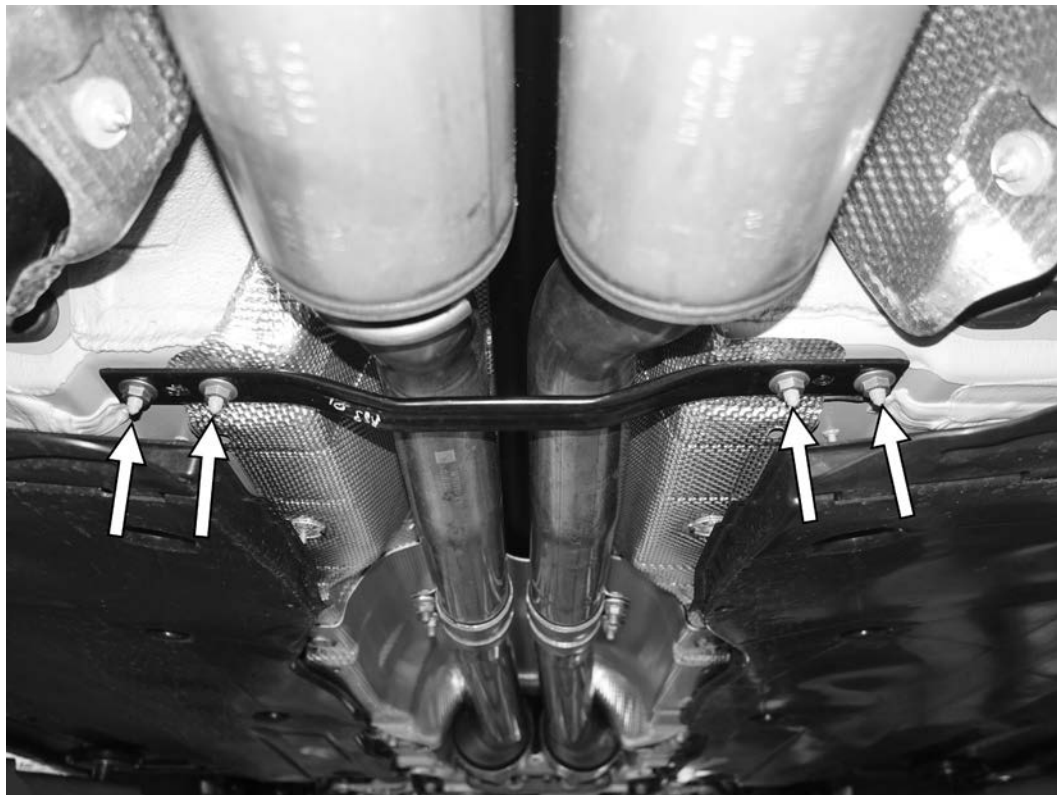

TL100162

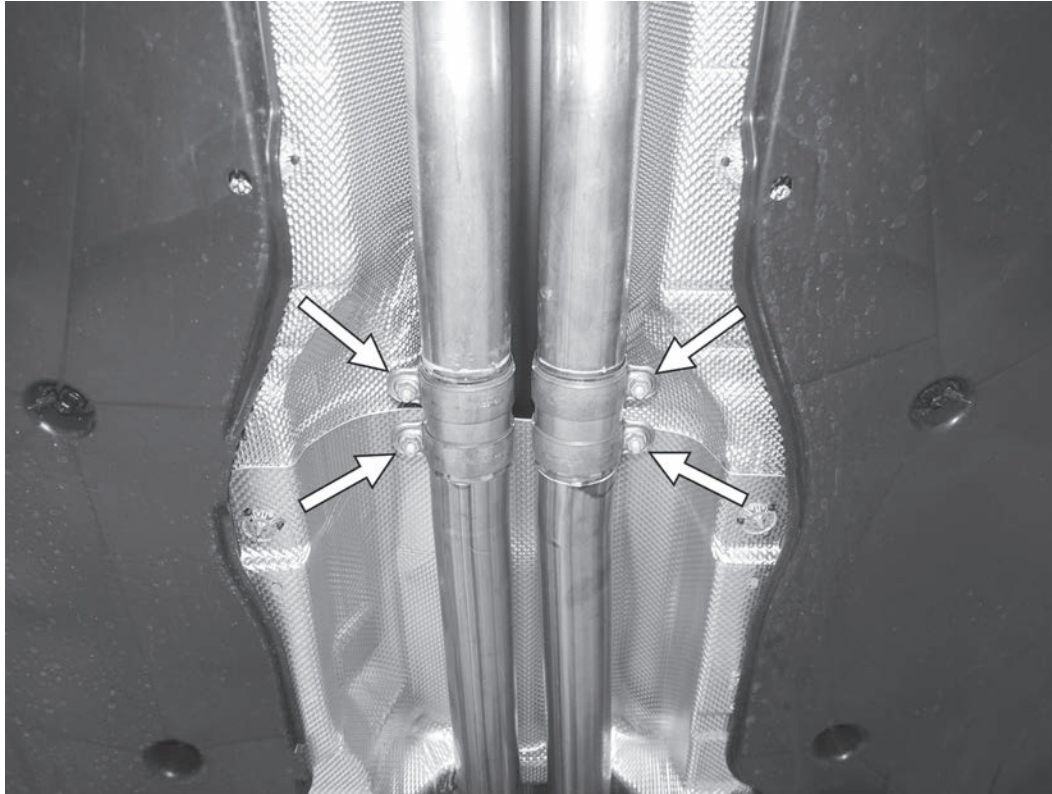

3) Loosen the 13mm nuts on the two exhaust clamps at the center of the exhaust, but do not slide the clamps out of their current location.

4) Disconnect the electrical connector to both rear exhaust valve motors on both sides of the rear muffler. Slide the clip holding the wiring harness for the exhaust valve motors off the rear exhaust hangers.



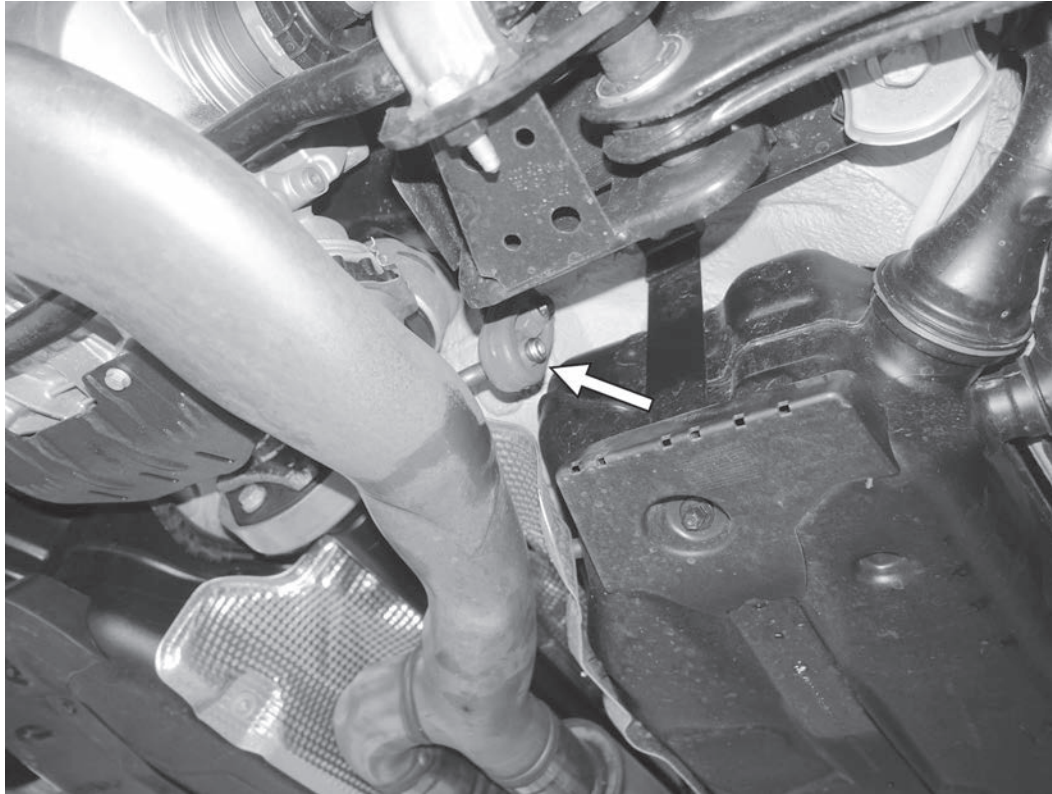

5) Disconnect the two rubber hangers from the center of the exhaust system (the one shown and the one slightly further forward on the left side), leaving the hangers attached to the car.

6) Support the rear muffler section of the car with a jack.



TL100162

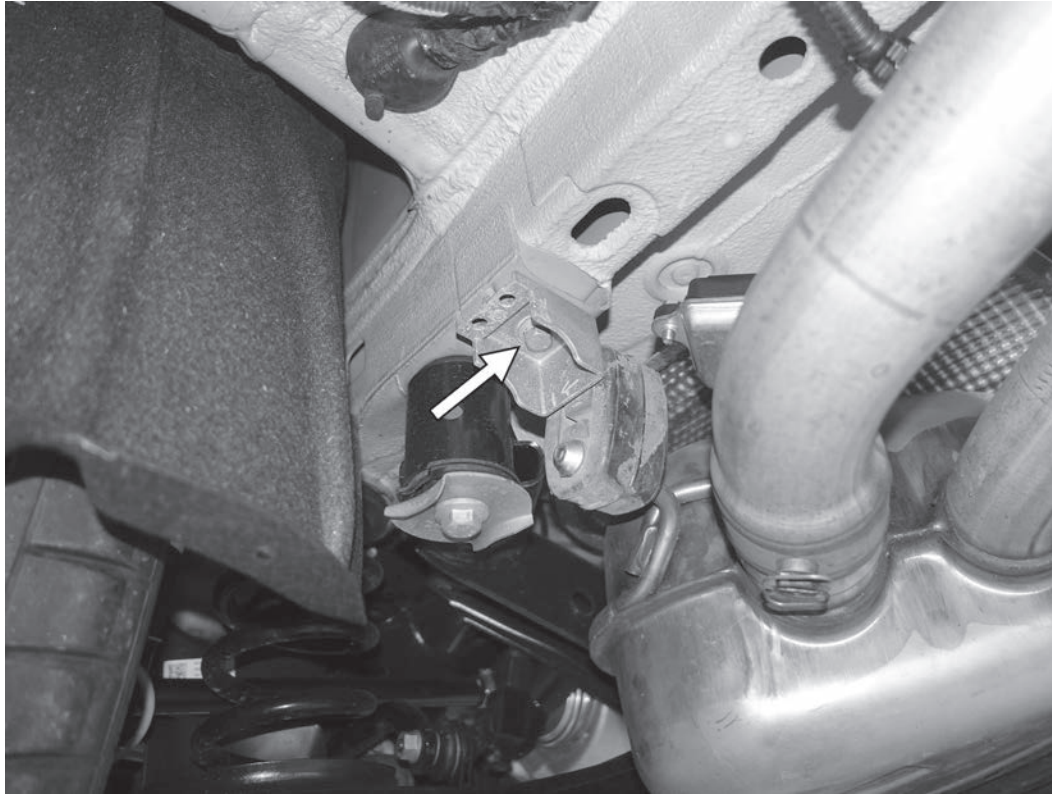

7) Remove the two 13mm bolts holding both rear exhaust hangers to the muffler section.

8) Slide the two exhaust clamps at the center of the exhaust forward, and then carefully lower the front pipes of the rear muffler section from the center of the exhaust. Then, lower the rear muffler section from the car while sliding the assembly forward and out of the rear exhaust tips on the rear bumper.



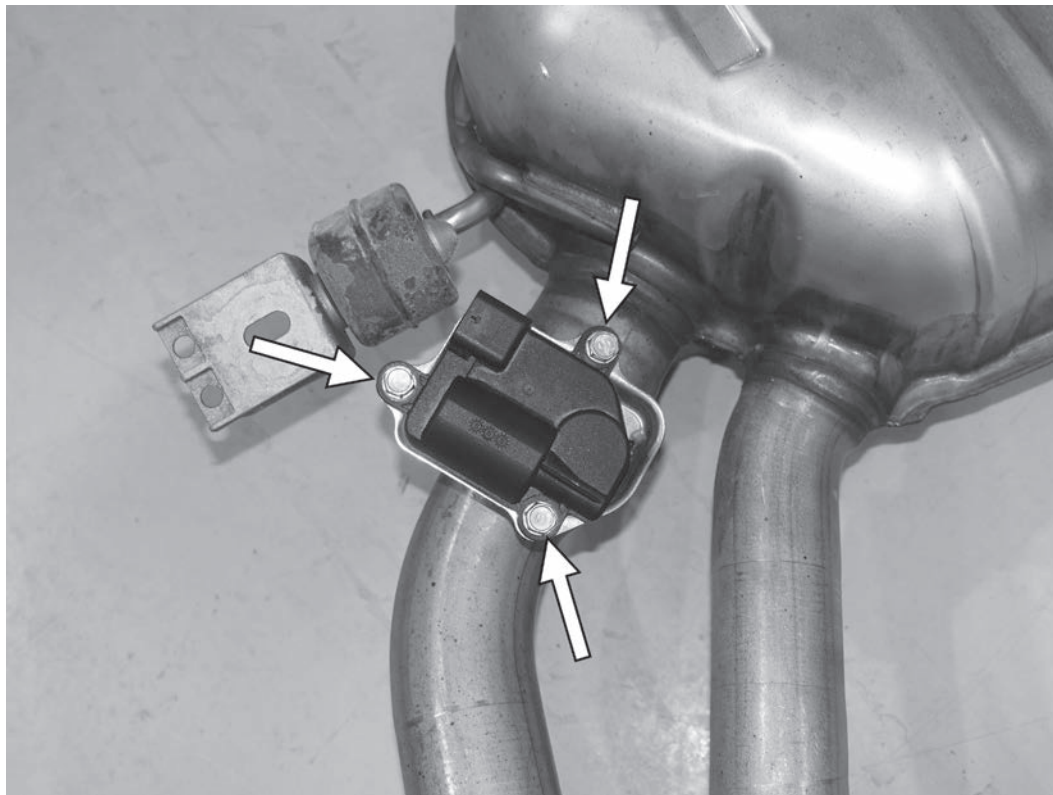

9) Remove the six 10mm screws holding both exhaust valve motors to the rear muffler assembly, and remove the valve motors from the exhaust. Also remove the springs that were between the valve motors and the valve.

10) The valve configuration varies depending on model. If the valve had a spiral spring, install the supplied APR spring adapter to the APR valve mount on the APR exhaust as shown. The pointed tab of the adapter should be mounted fully clockwise between the two “stop” posts on the bracket.

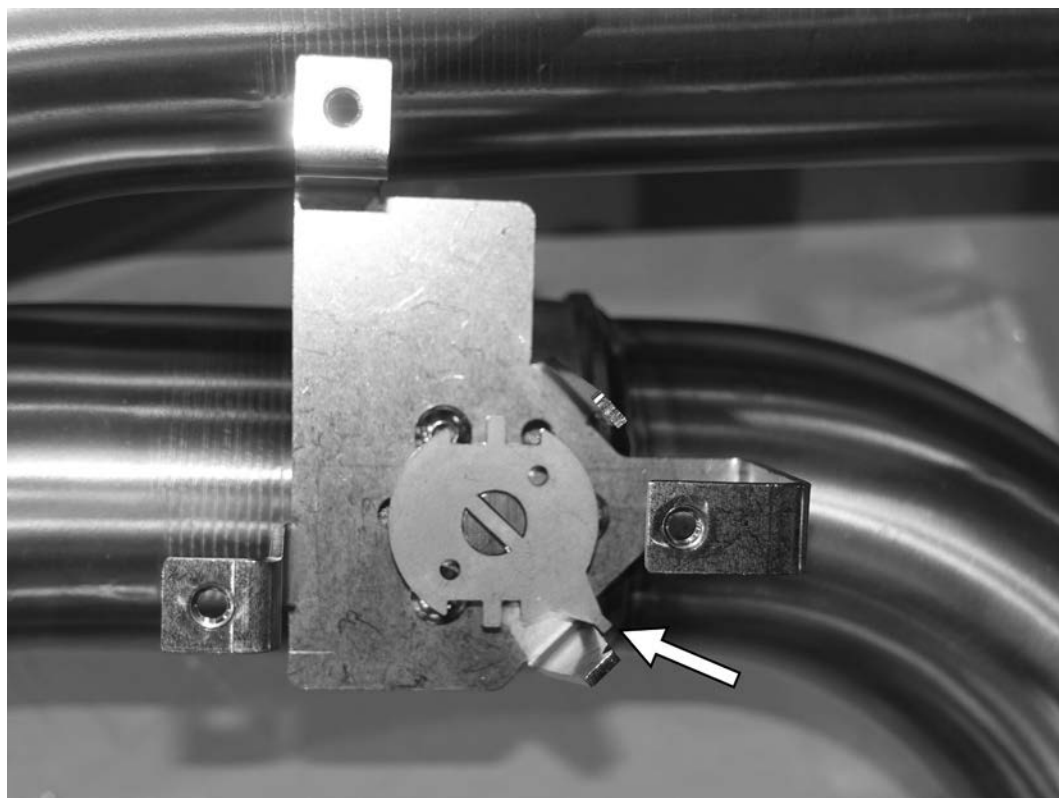

TL100162

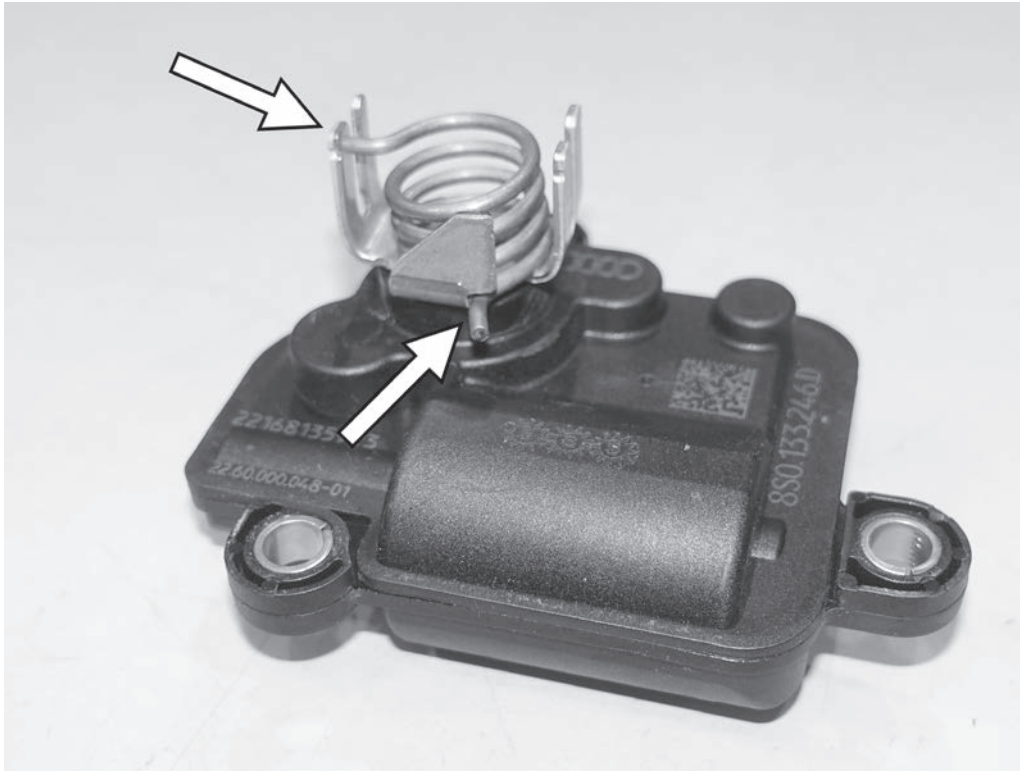

11) Install the factory spring on the factory exhaust valve motor as shown. One tab of the spring connects to the notch near the base of the valve motor, and one tab goes between two of the vertical tabs on the motor.

12) Place the exhaust valve motor and spring onto the APR exhaust bracket. The four vertical tabs on the exhaust valve motor key into the four slots on the APR spring adapter. Ensure the two tabs on the factory spring are still in their correct place before installing the three supplied 4mm allen screws and washers. Tighten the screws to 9Nm (80 in-lbs). Repeat this process for installing the other exhaust valve motor on the other side of the muffler.



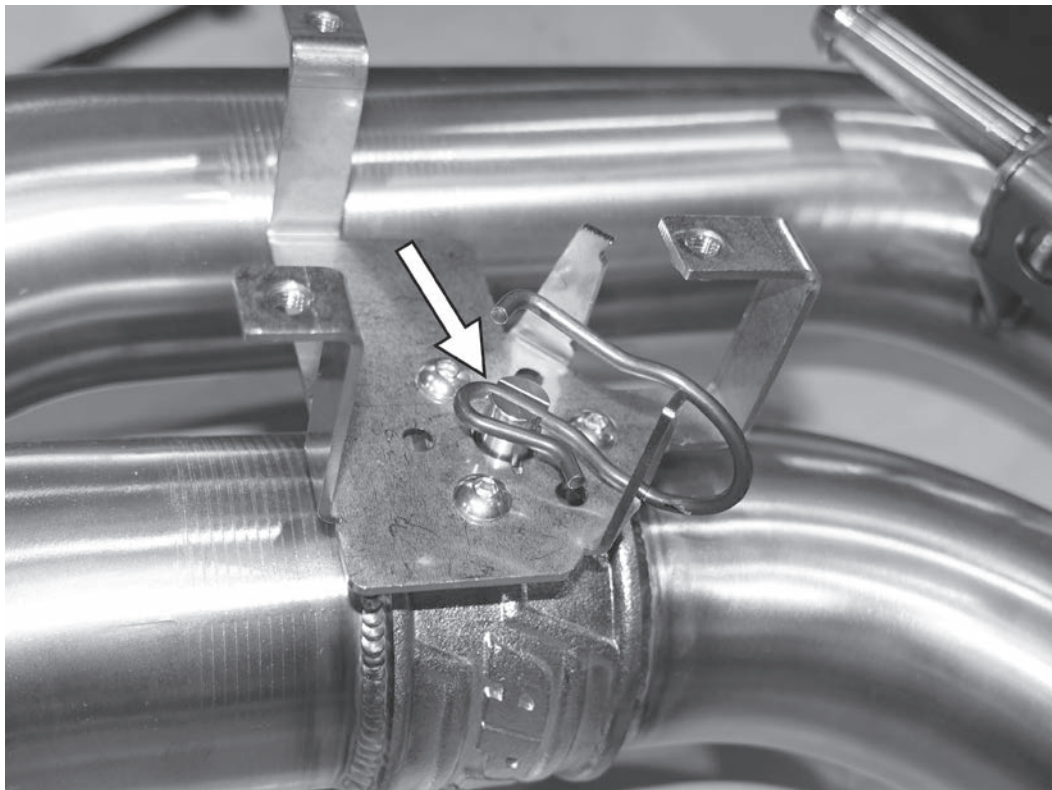

13) If your exhaust valve configuration had the D-shaped spring instead of the spiral spring, install the D-shaped spring onto the slot on the top of the APR valve. The arm of the spring should be mounted fully clockwise between the two "stop" posts on the bracket.

APR

14) Install the exhaust valve motor making sure the top tab of the D-shaped spring goes into the slot on the bottom of the exhaust valve motor. Secure the motor by installing the three supplied 4mm allen screws and washers. Tighten the screws to 9Nm (80 in-lbs). Repeat this process for installing the other exhaust valve motor on the other side of the muffler.

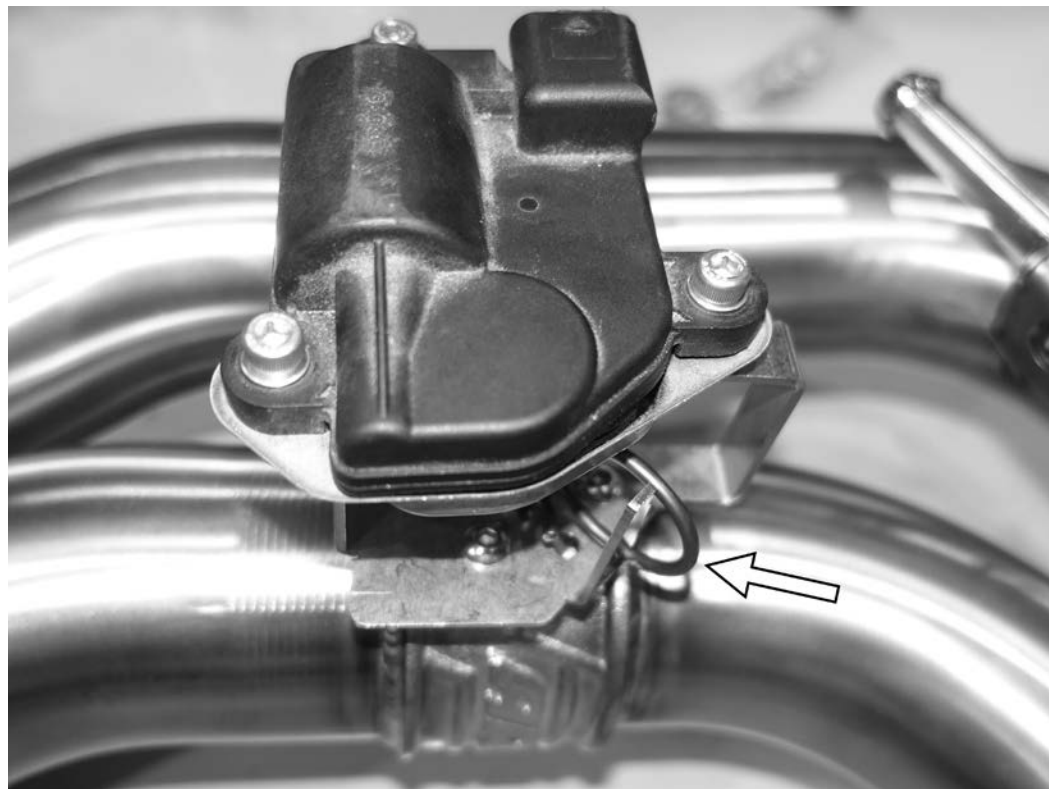

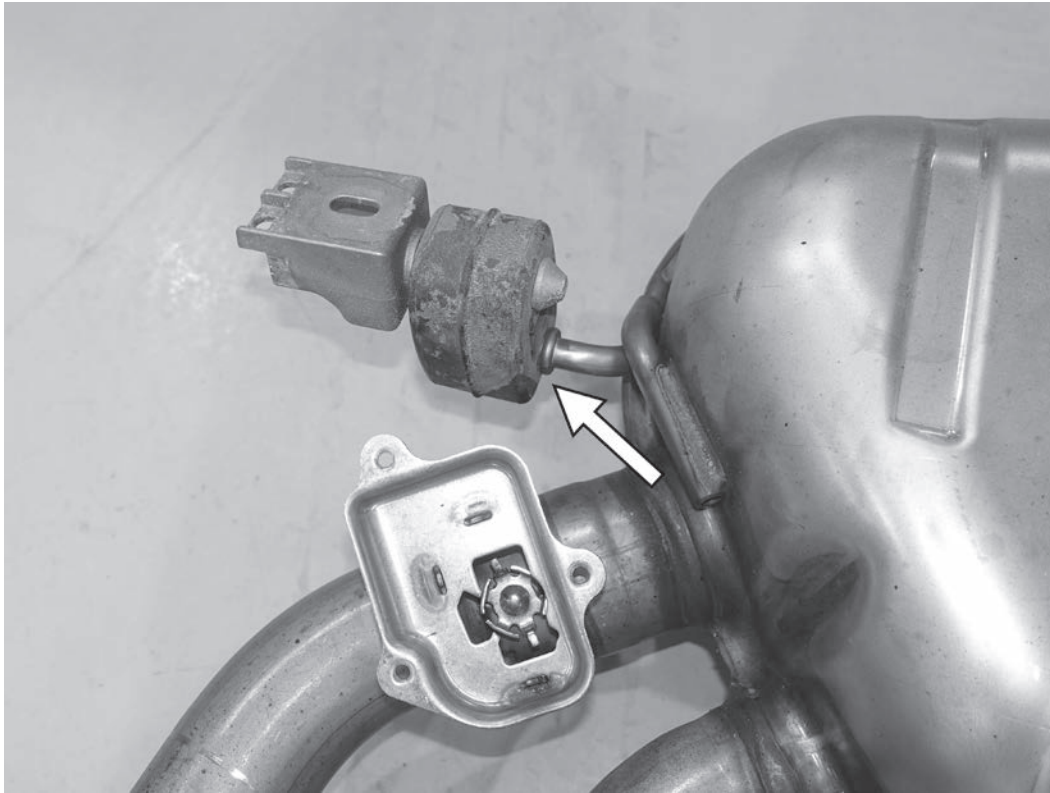

15) Remove the two exhaust hanger brackets with rubber mounts from the factory exhaust, and install them onto the APR exhaust in the same locations.

APR

16) Install the APR rear muffler assembly onto the car, sliding the exhaust outlets into the exhaust tips on the back of the bumper. Support the exhaust with a jack, and then loosely install the two factory 13mm screws to hold the exhaust hanger brackets to the car.



TL100162

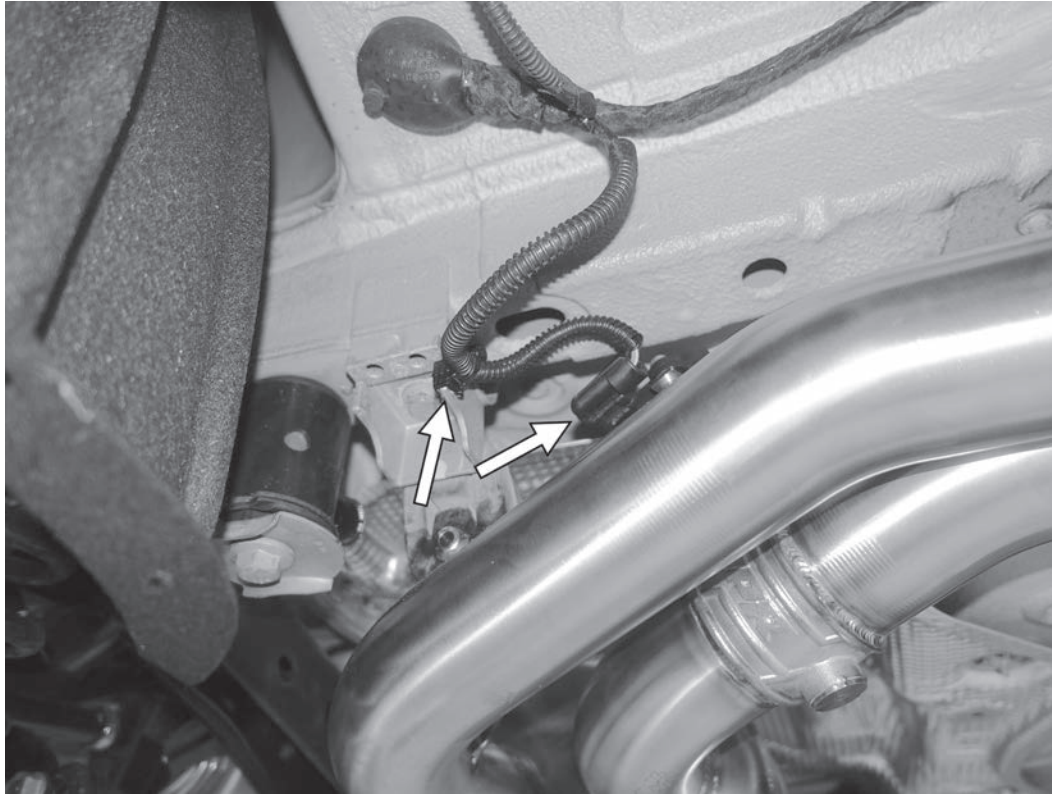

17) Reconnect the wiring harness to both exhaust valves, and then reattach the harness clips onto the metal exhaust hanger bracket.

18) Build the rear section assembly of the APR exhaust using the two pipes and two 13mm screws. Do not tighten the screws yet.

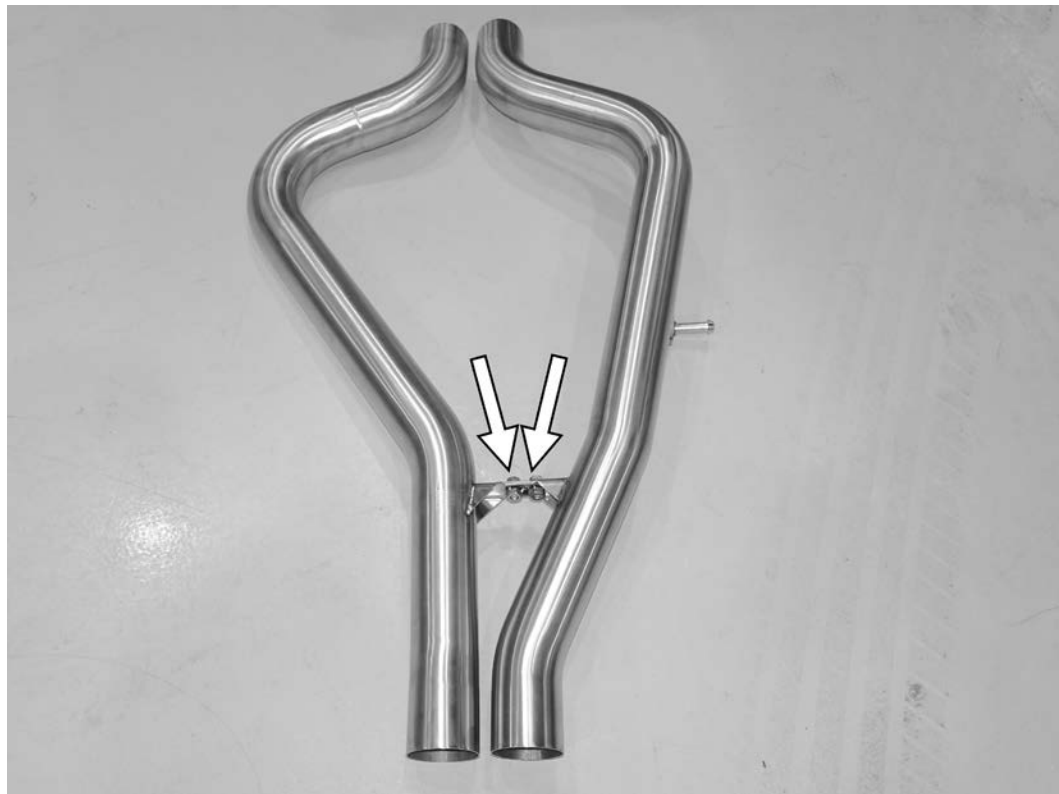

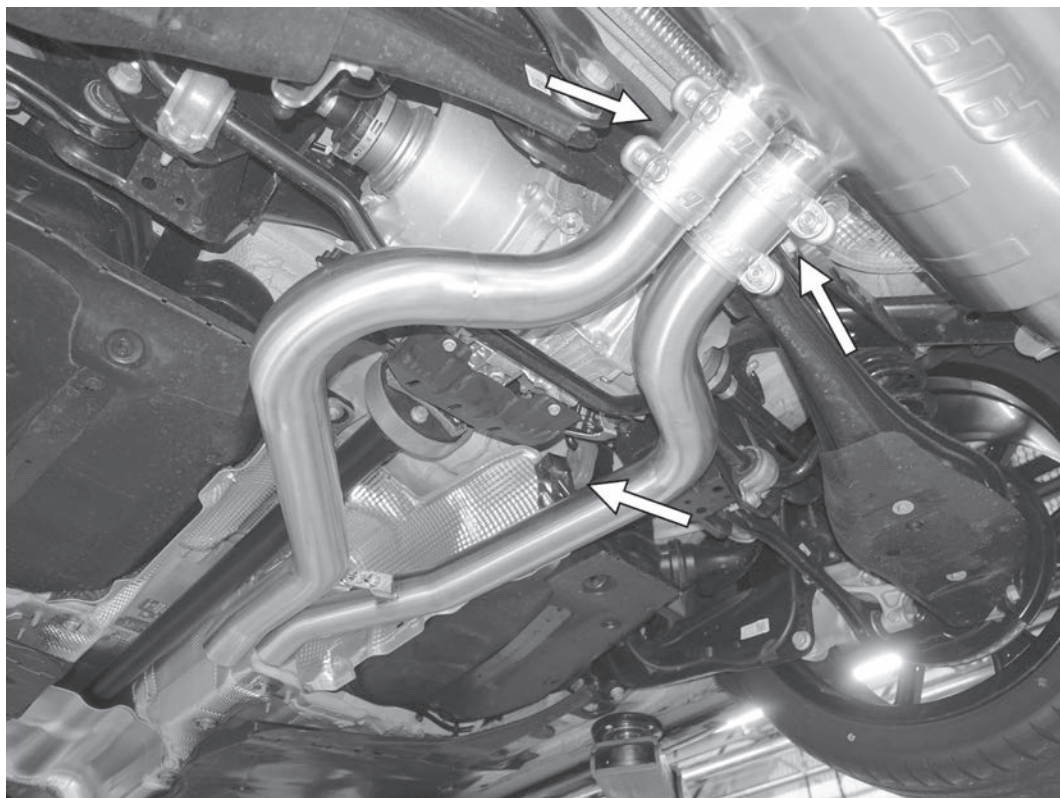

19) Loosely install the rear section assembly with two of the supplied APR sleeve clamps to the rear muffler as shown. Connect the exhaust mounting post onto the factory rubber hanger on the right side.

APR

20) Install the front APR exhaust section with the two factory clamps on the front side and the two remaining APR sleeve clamps on back side. Connect the exhaust mounting post onto the factory rubber hanger on the left side.

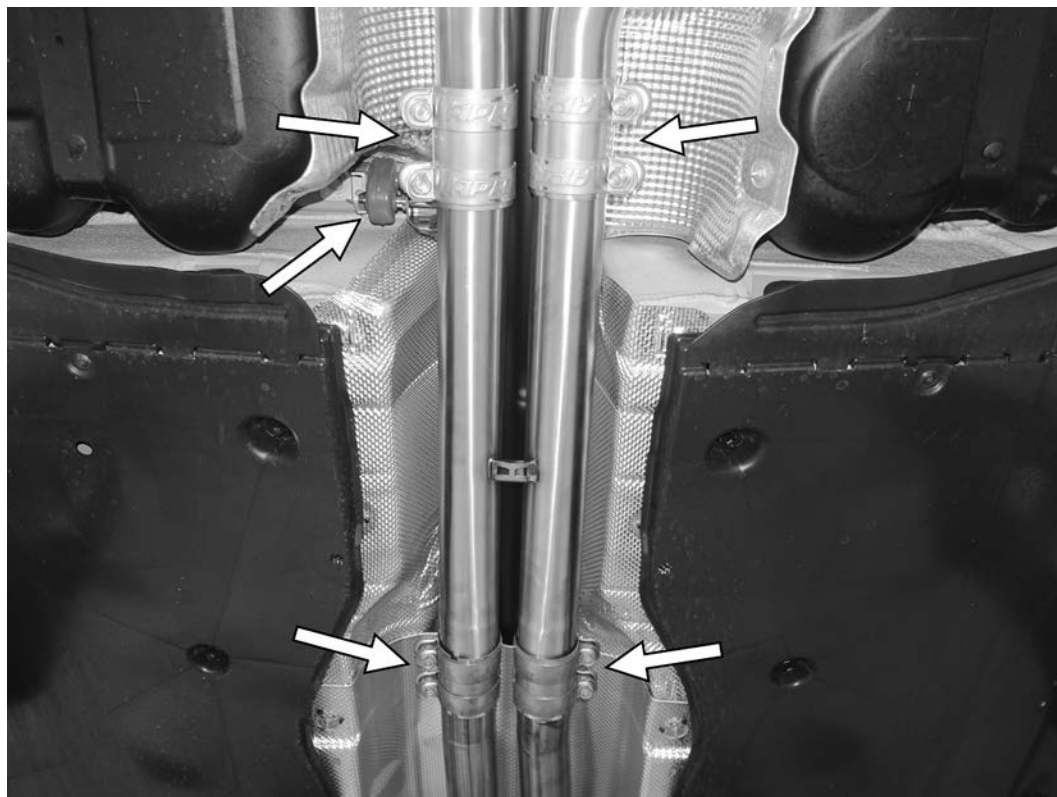

TL100162

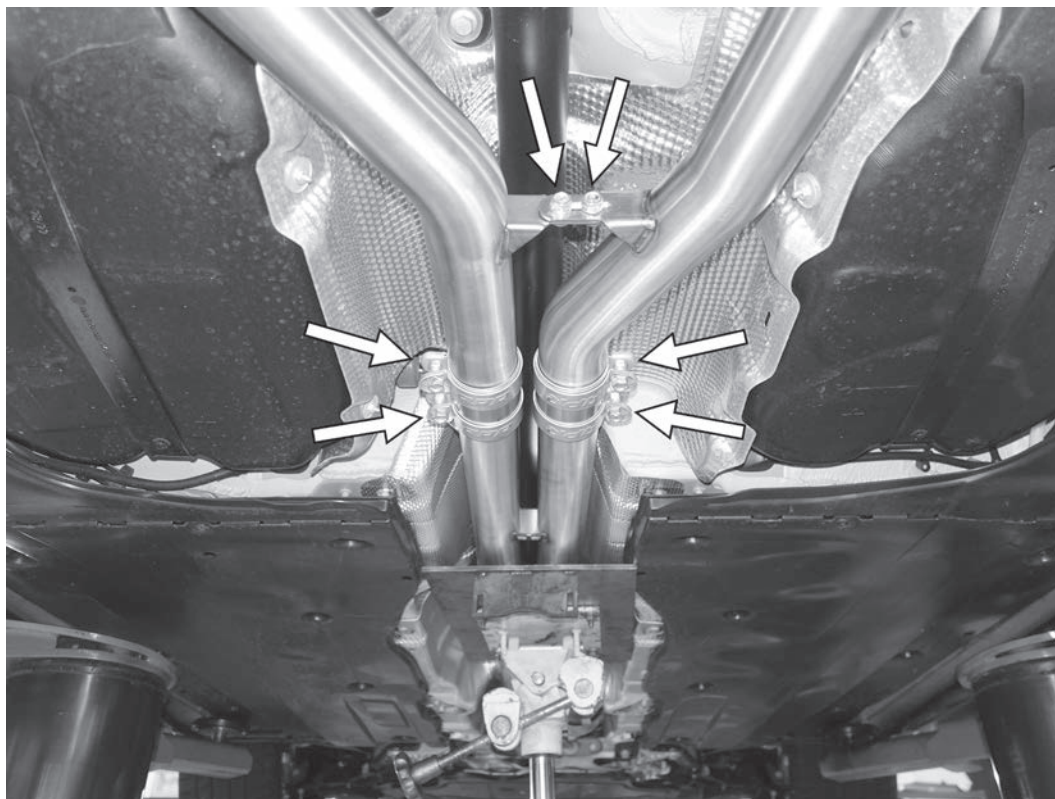

21) Support the front section of the exhaust, making sure it sits correctly in the center exhaust tunnel. Tighten the 13mm nuts on the factory sleeve clamps to 23Nm (17 ft-lbs). Tighten the 15mm nuts on the APR sleeve clamps to 35Nm (26 ft-lbs). Then, tighten the 13mm screws on the cross brace on the APR rear section to 10Nm (88 in-lbs).

APR

22) Tighten the two 13mm screws on the rear muffler hangers to 9Nm (80 in-lbs). Ensure the rear muffler outlets are sitting centered in the exhaust tip outlets on the rear bumper before tightening the four 15mm nuts on the APR sleeve clamps. Tighten the 15mm nuts to 35Nm (26 ft-lbs).



TL100162

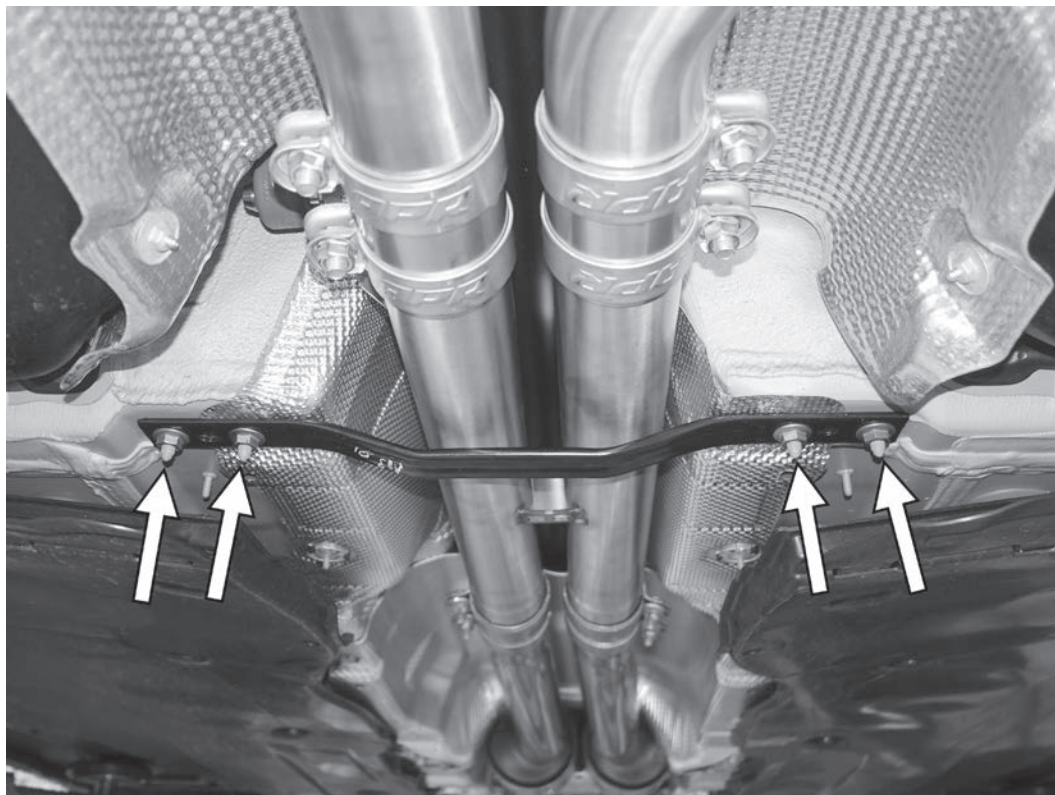

23) Reinstall the factory crossbrace with the four original 13mm nuts. Tighten the nuts to 20Nm (15 ft-lbs).

APR

24) Reinstall the six 10mm plastic nuts to secure the underbody panels on the car. Tighten the nuts to 2Nm (18 in-lbs).

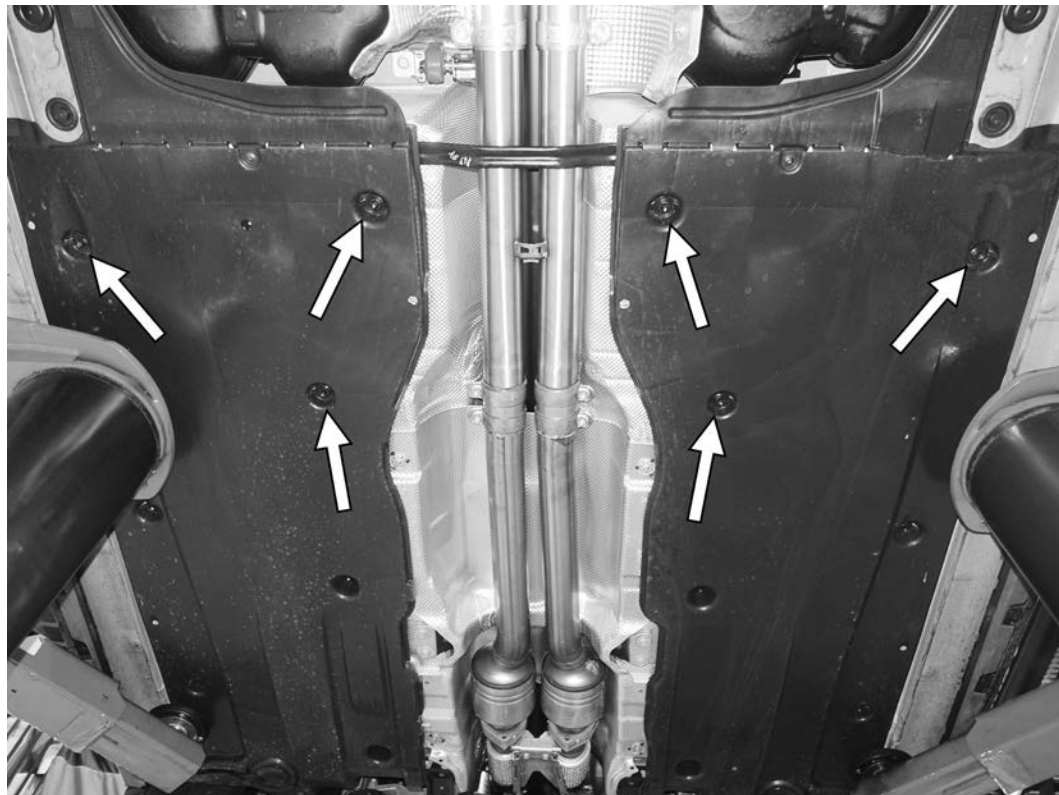

TL100162

APR

#TL100162

GO APR.COM