



DINAN

N63 Upgrade Intercooler Installation Instructions

Part Number: D330-0014

**Applications: 2011-13 F10 550i/iX
2010-12 F07 550i/iX GT
2011-12 F12/F13 650i/iX
2009-12 F01/F02 750i/iX/Li/LiX**

PARTS LIST

<u>Qty</u>	<u>Part No.</u>	<u>Description</u>
2	11 78 7 549 563	CABLE CLAMP
1	17 12 7 977 704	COOLANT HOSE; BOTTLE/IC LONG
1	17 12 7 977 729	COOLANT HOSE; BOTTLE/IC SHORT
1	D332-0030	VENT VALVE BRACKET
1	D332-0031	IC BRACKET LEFT
1	D332-0032	IC BRACKET; RIGHT
1	D333-0012	INTERCOOLER 5-8; COMPLETE
1	D332-0013	INTERCOOLER 1-4; COMPLETE
1	D340-0801	SILICONE HOSE; IC INLET LEFT
1	D340-0802	SILICONE HOSE; IC INLET RIGHT
1	D381-0283	5/16" Y CONNECTOR
1	D393-0024	VENT HOSE A; 8MM X 8"
1	D393-0025	VENT HOSE B; 8MM X 18"
5	D670-0227	HOSE CLAMP; 9/32X14.5 PINCH
2	D670-0228	HOSE CLAMP; 9MMX48.5MM PINCH
2	D670-0229	HOSE CLAMP; 9MMX68.0MM PINCH
2	D671-0133	M6 X 20 M/F STANDOFF
1	D671-0142	8MM BALL JOINT STUD
2	M6 NYLOK	M6X1.0P NYLOK NUT
1	M6 SCHNORR	WASHER
5	M6 WAVE	WASHER
2	M6x12	M6X12X1.0P BOLT
1	M6x12	M6X12X1.0P BUTTON HEAD BOLT
2	M6x16	M6X16X1.0P BOLT
5	M6X18 FENDER	WASHER

Software download: After installing the Upgrade Intercooler you will be safe to install the appropriate software download. If this kit is not installed at a Dinan dealer you can drive to the nearest Dinan Dealer to receive the tuning and boost increase that is optimized for your new Dinan Intercooler. It is safe to drive the vehicle with the Intercooler Upgrade to the dealer before the new software is installed.

Note: For maximum power output always use premium fuel. Unleaded racing fuel can be used on occasions such as track events when even more power is desired.

REMOVE THE STOCK INTERCOOLER

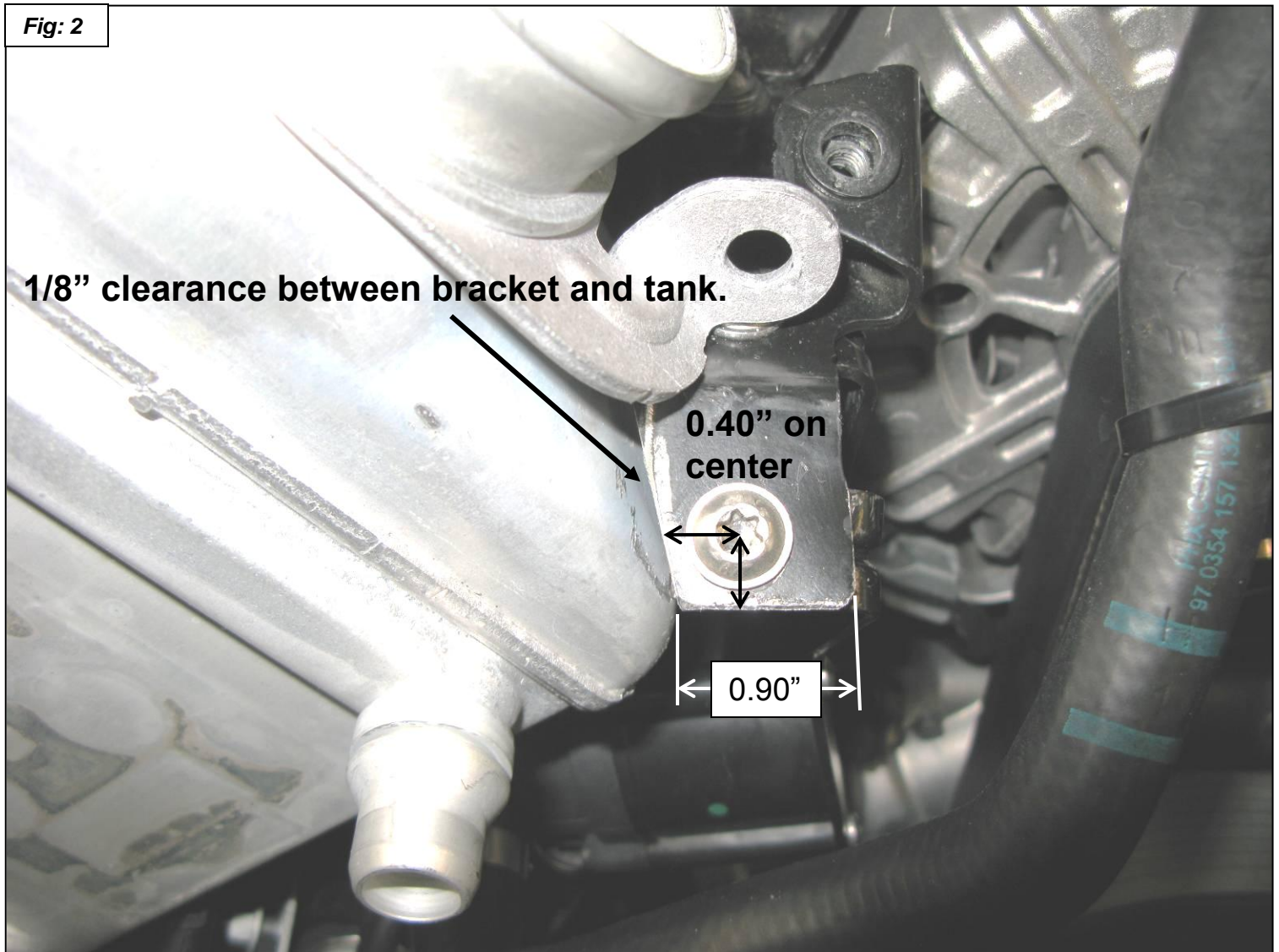
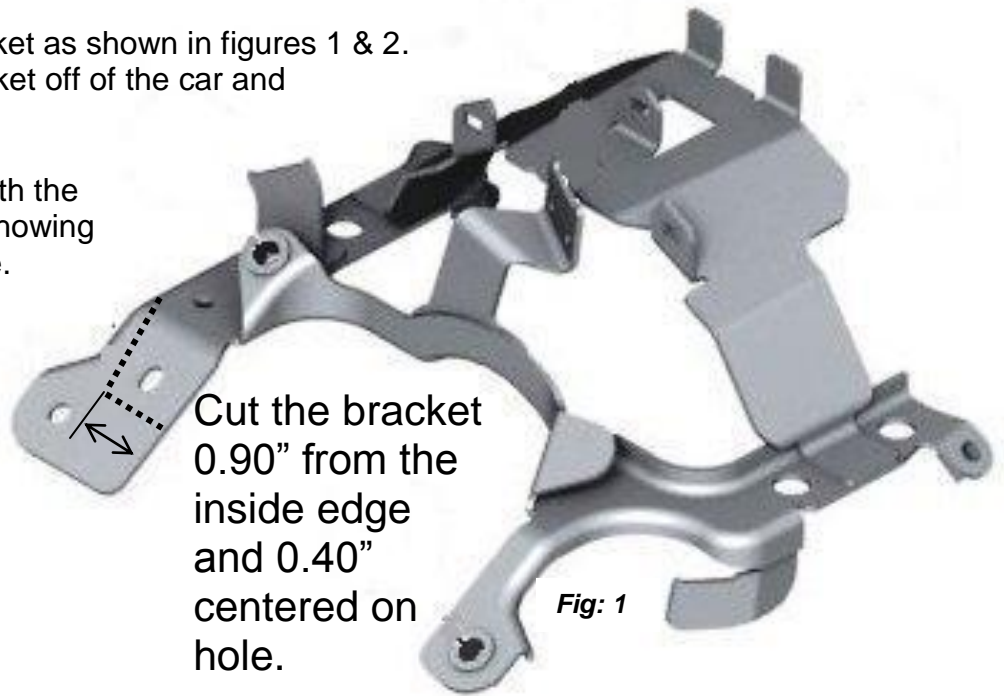
1. Remove the stock intercooler from the car using the BMW TIS procedure # 17 51 001. It helps if you remove the fan cowl with electric fan using BMW TIS procedure # 17 11 035.

MODIFY PARTS FOR INTERCOOLER INSTALL

2. There are a few parts that need to be modified before installing the new Dinan intercoolers.
3. The bracket that holds the coolant reservoir for the intercoolers needs to be modified.
4. Remove the intercooler expansion tank and hoses. Cover the throttle bodies, turbos and alternator to keep any cutting debris from entering when trimming reservoir bracket.

5. Cut the expansion tank bracket as shown in figures 1 & 2. Figure 1 shows the raw bracket off of the car and where to cut it.

Figure 2 is the cut bracket with the Dinan intercooler installed, showing where you needed clearance.



6. Remove the metal hose fittings from the charge air lines as shown in figures 3, 4 & 5. Clamp the charge air line in a vise and cut the clamp diagonally with a cut off wheel. Be careful not to cut the metal fitting. See figure 3. Peel the hose clamp off as shown in figure 4. Remove metal hose fitting as shown in figure 5. You will use these with the new charge air hoses.



Fig: 3



Fig: 4

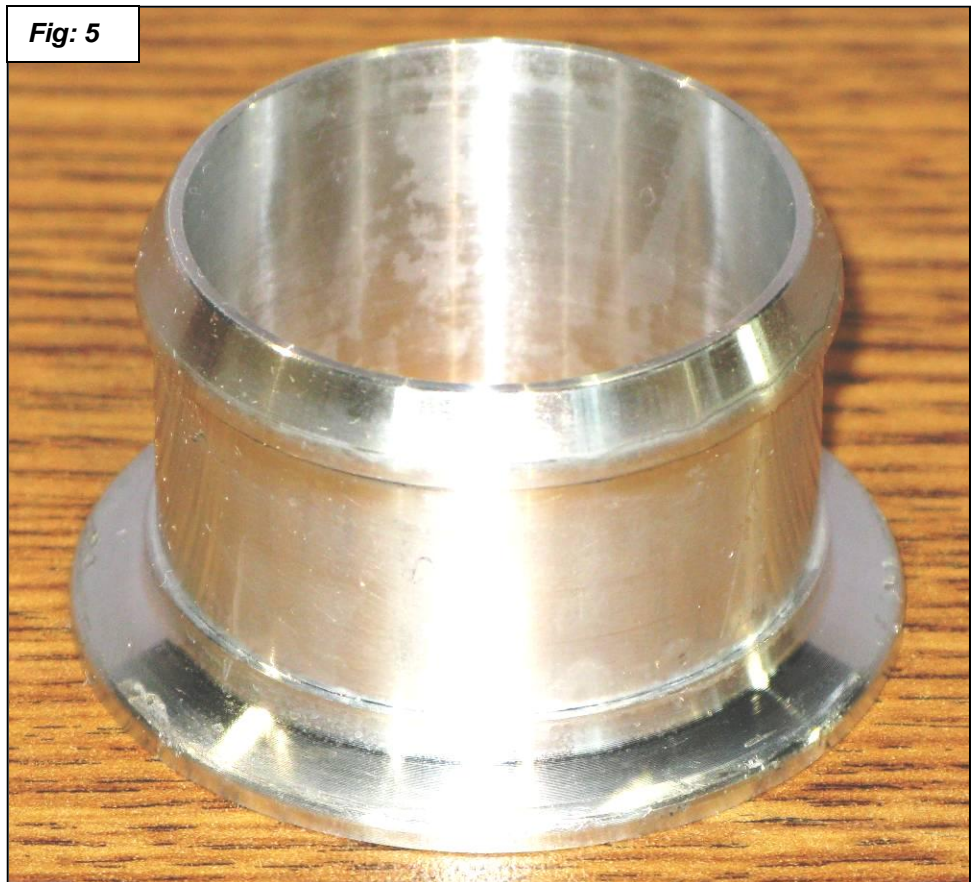


Fig: 5

7. Modify the engine cover/ sound protection cap as shown in figures 6, 7, 8 and 9. Tape the edge of the cover as shown and draw a line at the intersection where the stock hose outlets are evenly along the edge. Cut the cover along this line. A die grinder with a cut off wheel works well. Sand the edge flat and smooth.



Fig: 6



Fig: 7

8. Cut the mounting bracket as shown to remove the inner mount. Sand down the two raised bumps shown. Clean up the holes opened from sanding the bumps using files. Round out the lips on the cover in the two locations shown for clearance for the hose and expansion tank cap. See figures 8 and 9.



Fig: 8

Clearance for hose and expansion tank cap.

Remove inner mount.

Sand flat bumps and file holes smooth as shown.

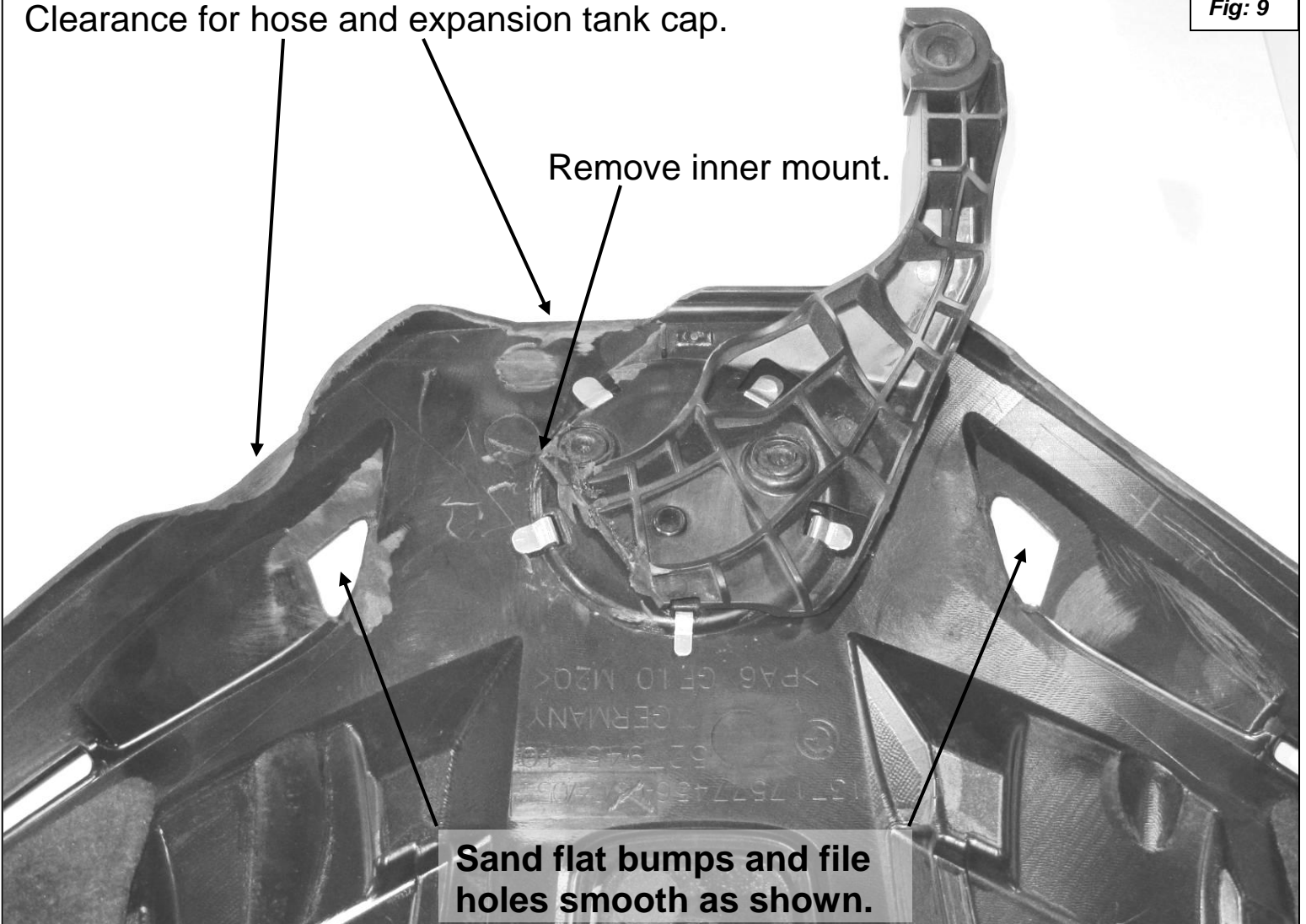
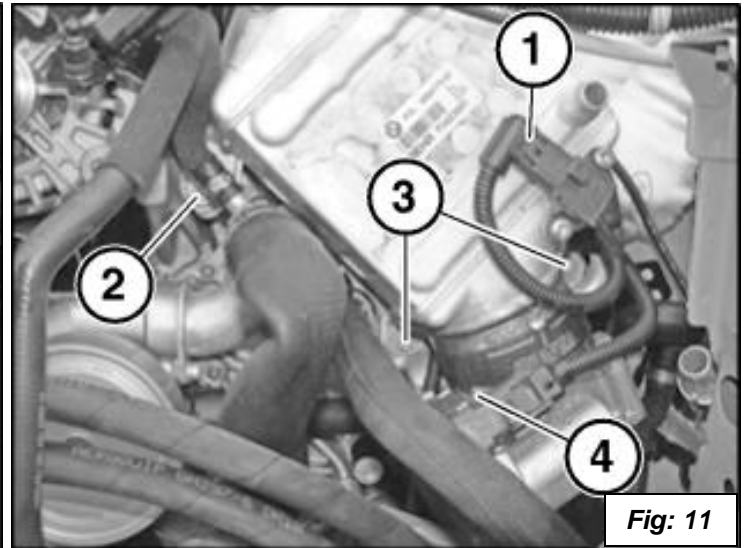
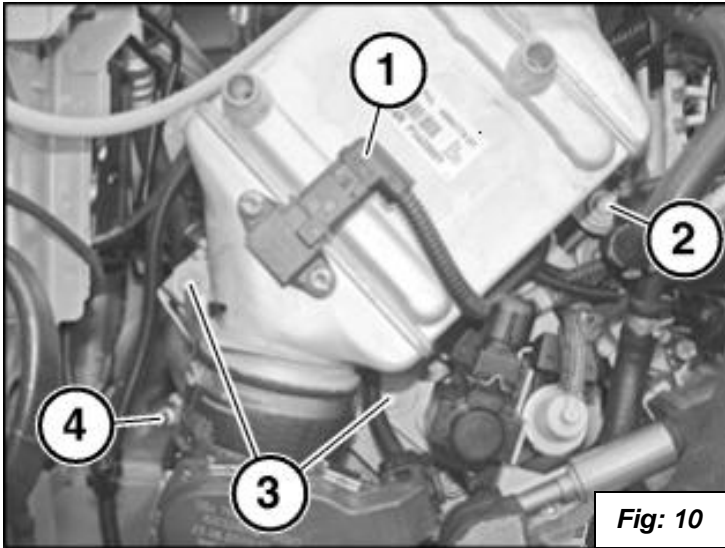


Fig: 9

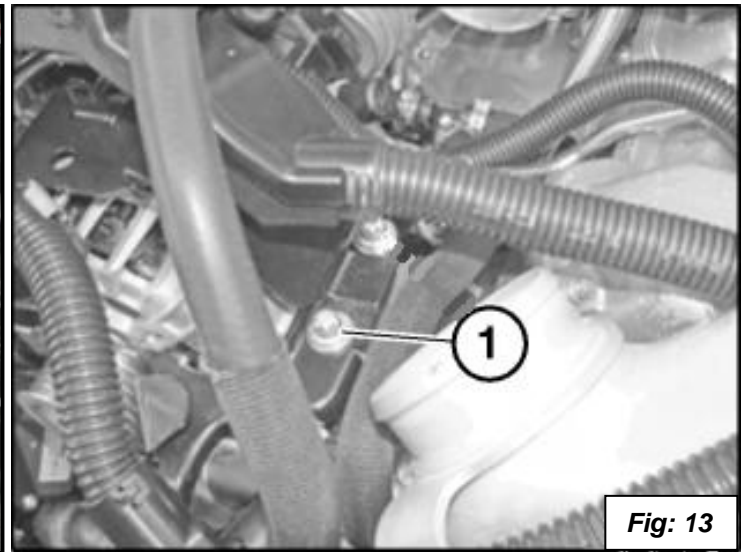
INSTALL THE DINAN INTERCOOLER

9. Reassemble the car in reverse of disassembly. There are some new hoses and brackets used in place of the stock ones. The following instructions will show you the changes.

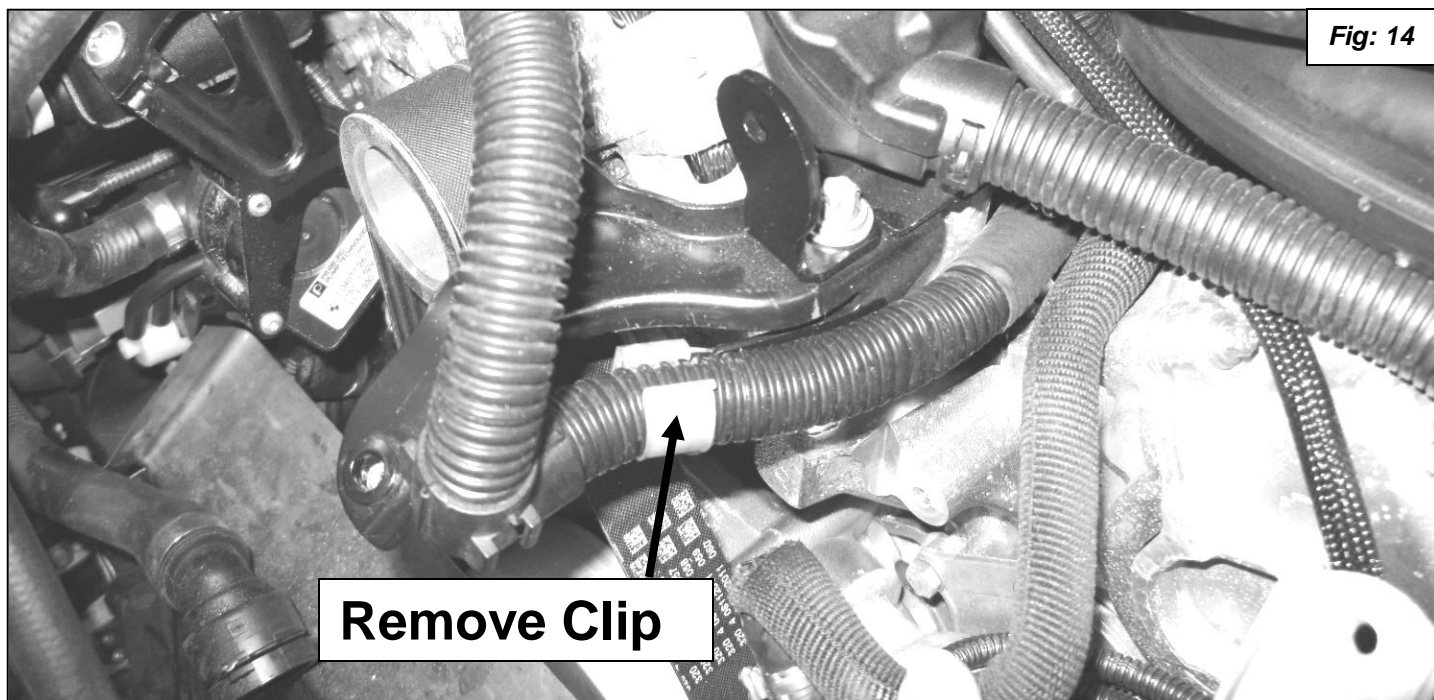
10. Transfer the pressure sensors (1) to the new Dinan intercoolers. The Dinan intercoolers will use two of the stock mounting bolts in the same location (3). The bolts in position (2) will not be used; they are relocated in step 12. Tighten the clamps in position (4). See figures 10 and 11.



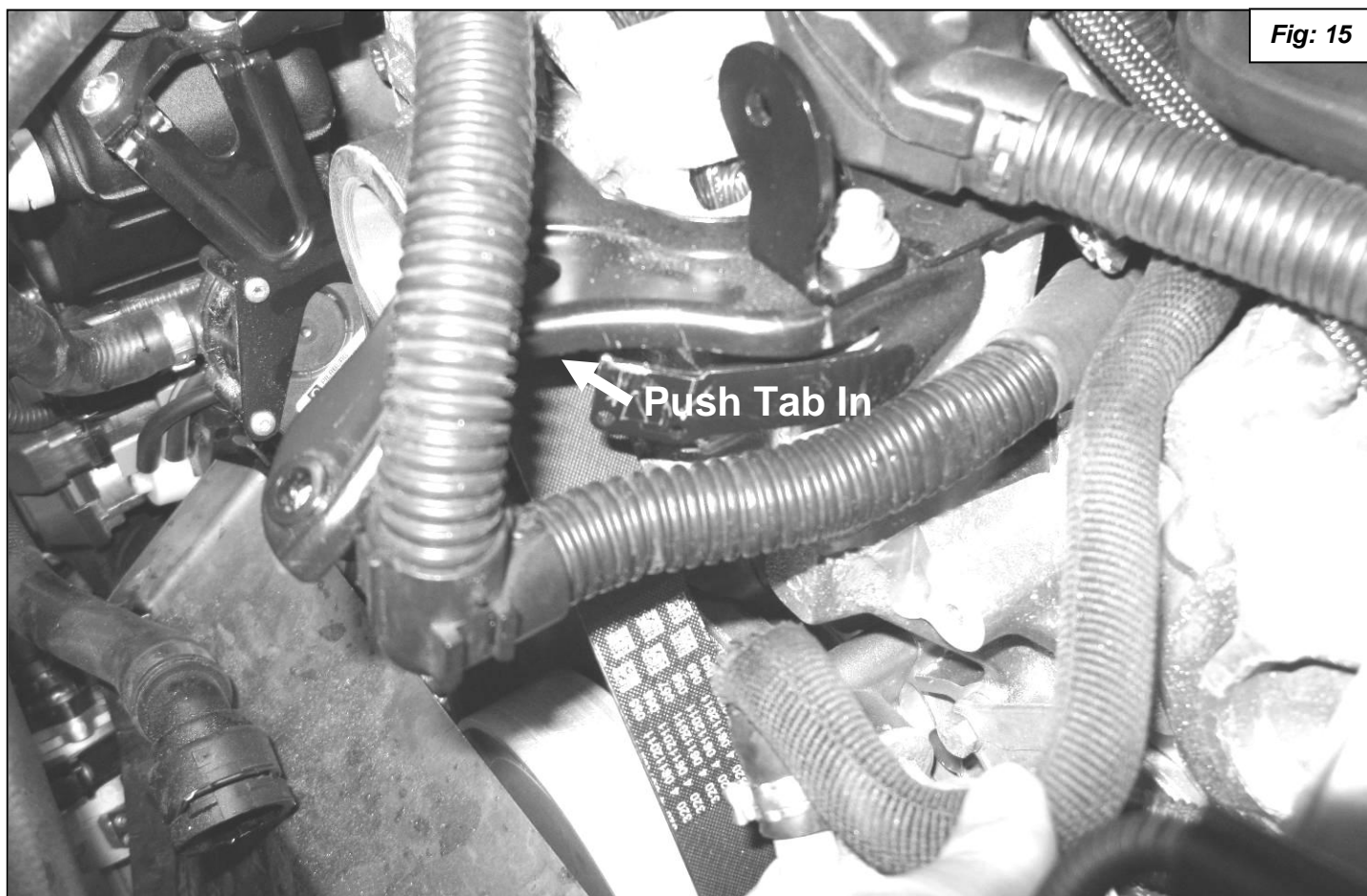
11. Remove the two forward alternator bolts (1) so you can install the new upper intercooler mounts under them. See figures 12 and 13.



12. Remove the clip shown in figure 14 to let the cable drop down slightly for clearance for the intercooler.



13. Bend the tab in slightly as shown in figure 15.



14. Install the new upper intercooler mounts as shown in figures 16 and 17. Torque the alternator bolts to 21Nm. Use the supplied 6mm bolts, washers and nylok nuts to attach the intercoolers to the brackets.

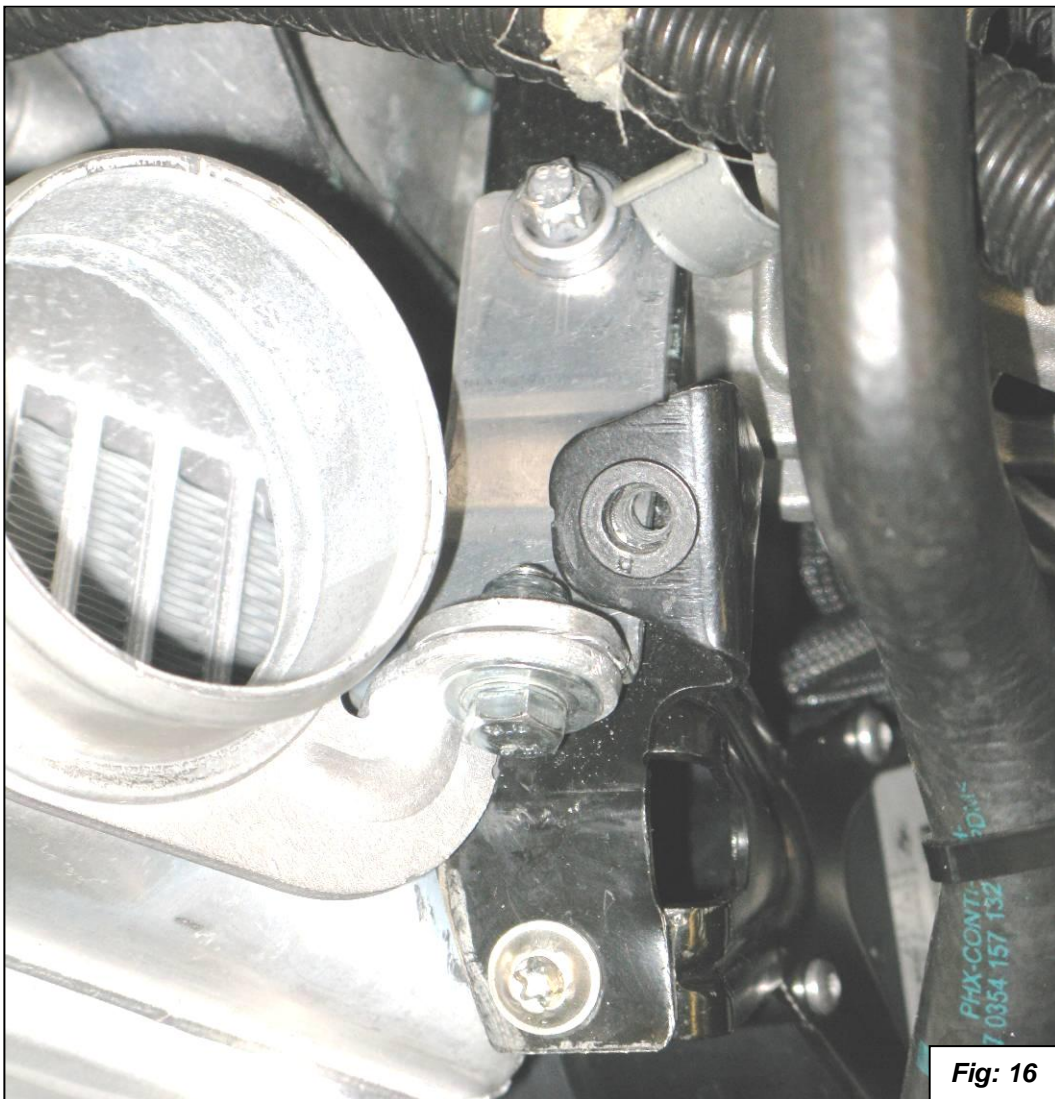


Fig: 16

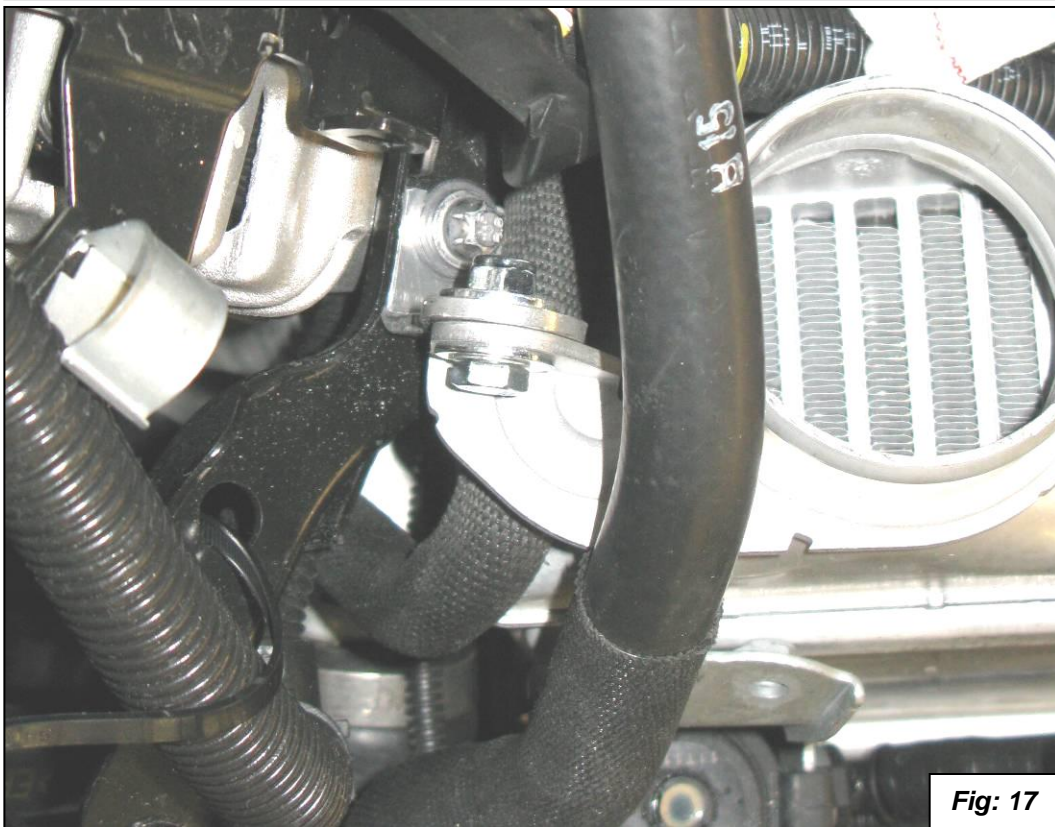


Fig: 17

15. Install the new vent valve bracket using the supplied 6mm bolts and washers. Install the vent valve on the bracket using the stock bolt. See figure 18.

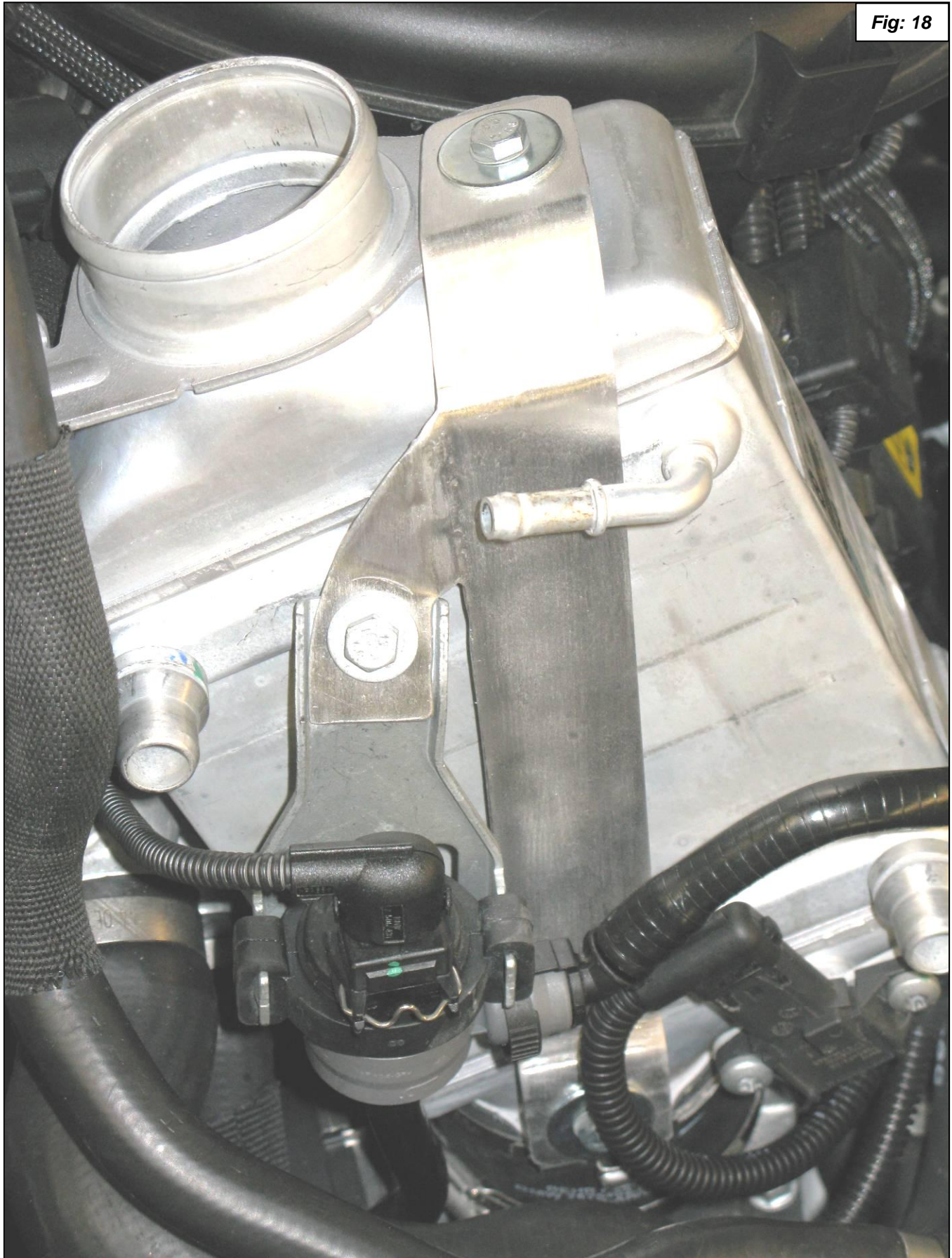
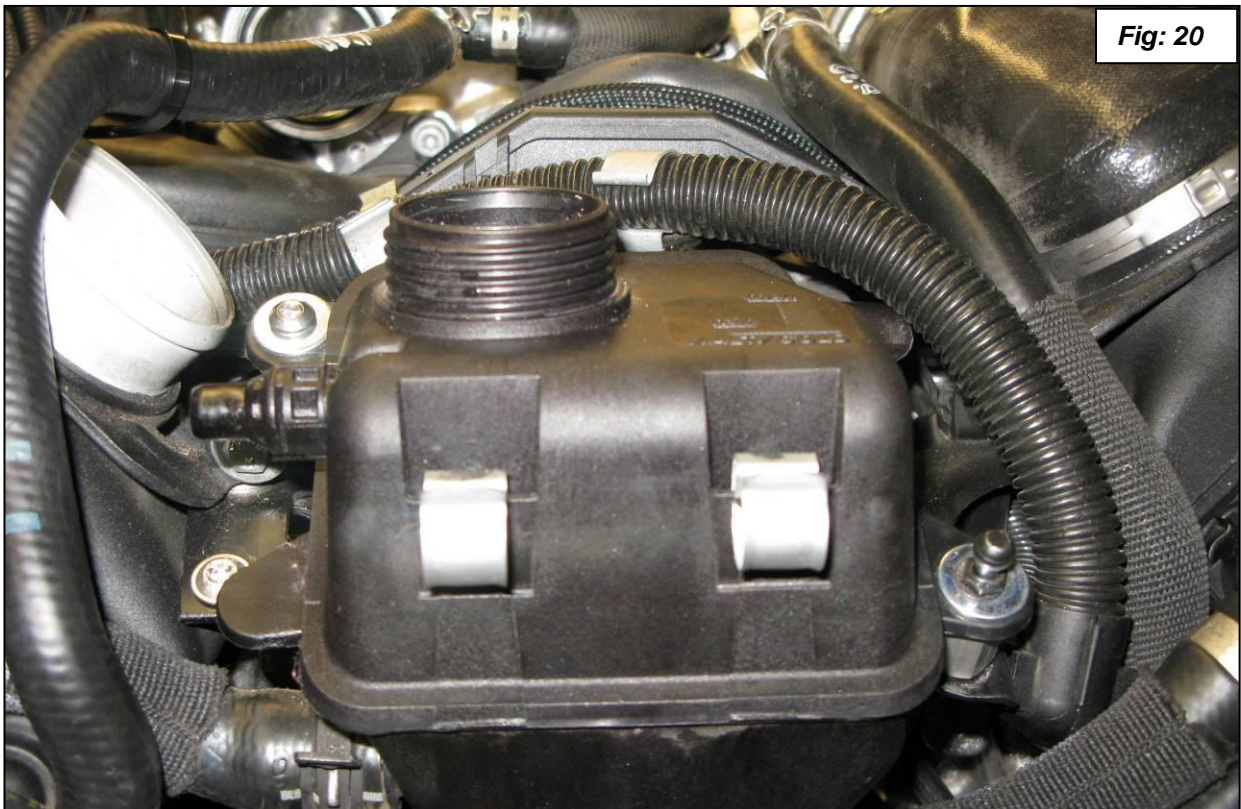


Fig: 18

16. Install the 6mm Male-Female threaded hex standoffs as shown in figure 19.



17. Install the expansion tank as shown in figure 20. Use the supplied 6mm button head bolt and washers on the passenger side and the ball stud, serrated washer and flat washer on the driver's side.



18. Install the Dinan hoses as shown in figure 21. Use the new crimp clamps with the metal hose fittings you removed in step 6.



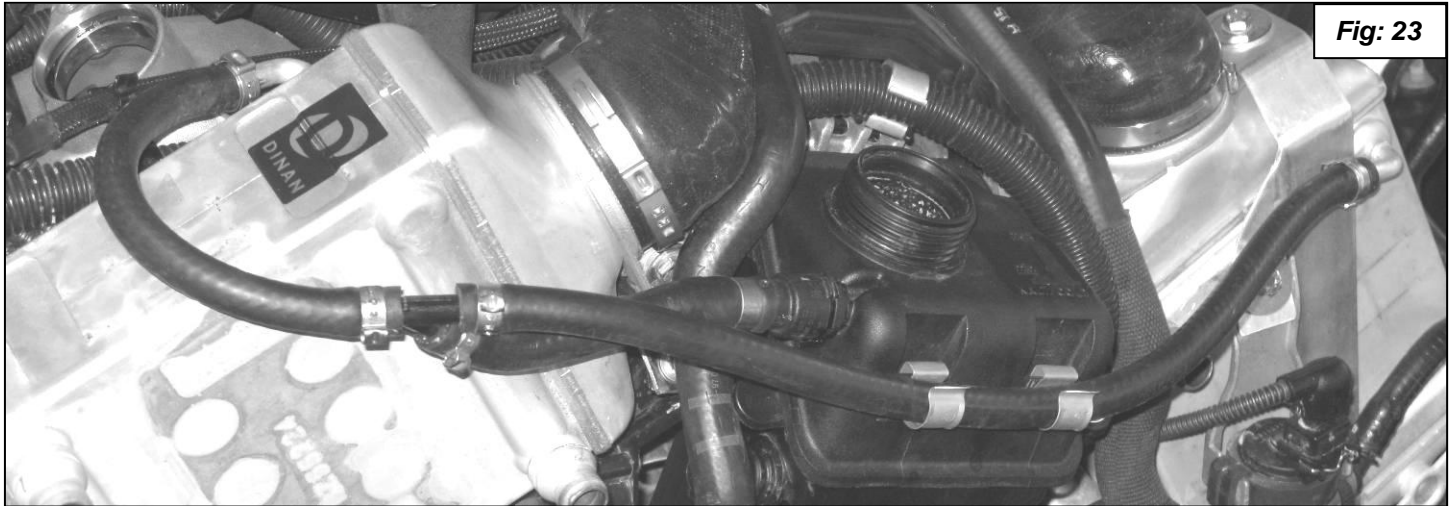
Fig: 21

19. Install the coolant hoses using the supplied new hoses where shown along with the stock hoses. See figures 22, 23, 24 and 25.

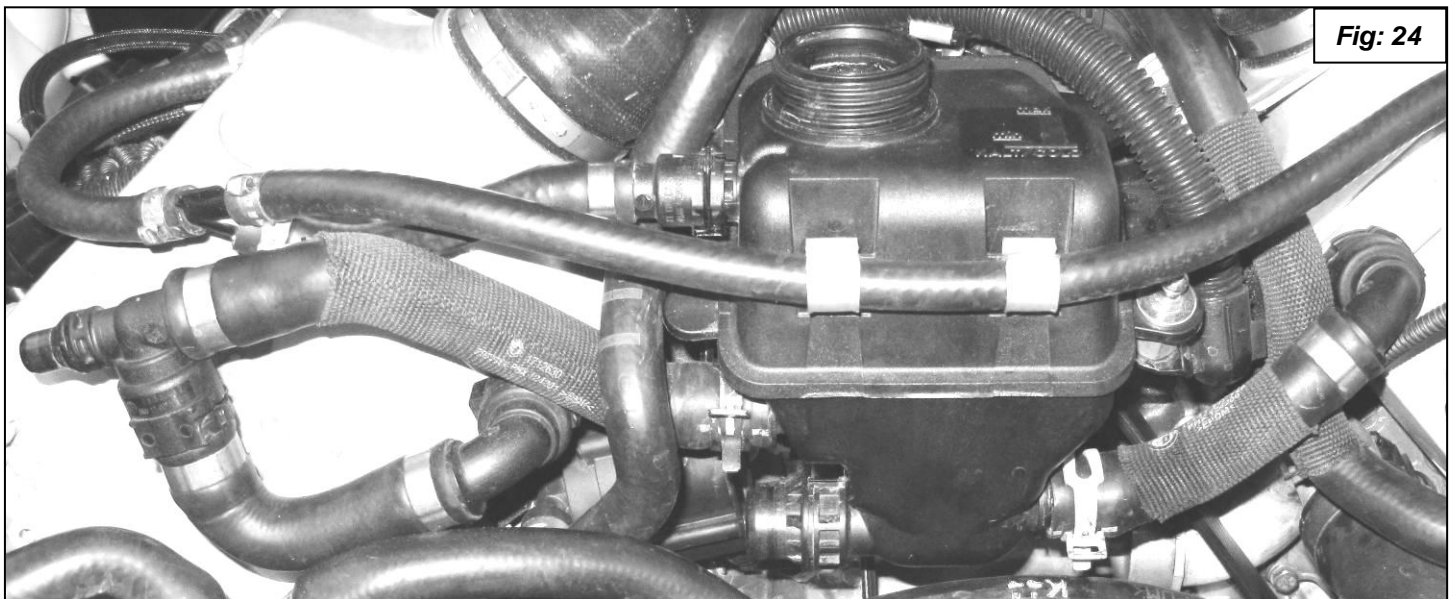


Fig: 22

20. Install the vent hose first with the Y connector into the stock hose that goes into the reservoir and the other two hoses going to the inter coolers. Clip the hose to the reservoir with the supplied clips. See figure 23.



21. Install the two new hoses that go between the reservoir and the inner nipples on the intercoolers. See figure 24.



22. Connect the hose from the computer tank to the passenger side hose you just installed as shown in figure 25.



23. Connect the hose from the pump to the bottom of the reservoir making sure it is still in the clamp that will hold it to the fan. See figure 26.

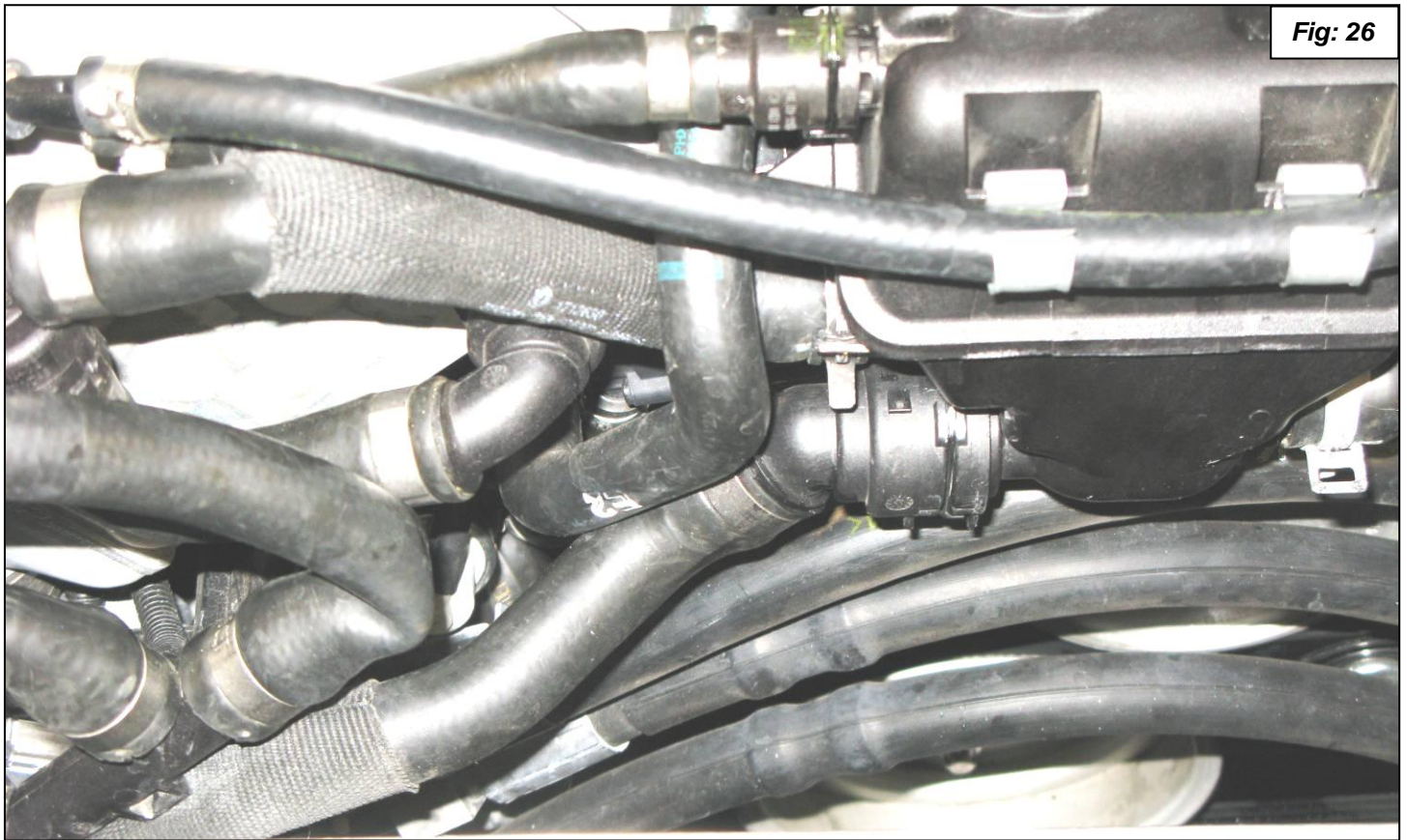


Fig: 26

24. Connect the two hoses from the pump to the outer nipples on the intercoolers as shown in figure 27.

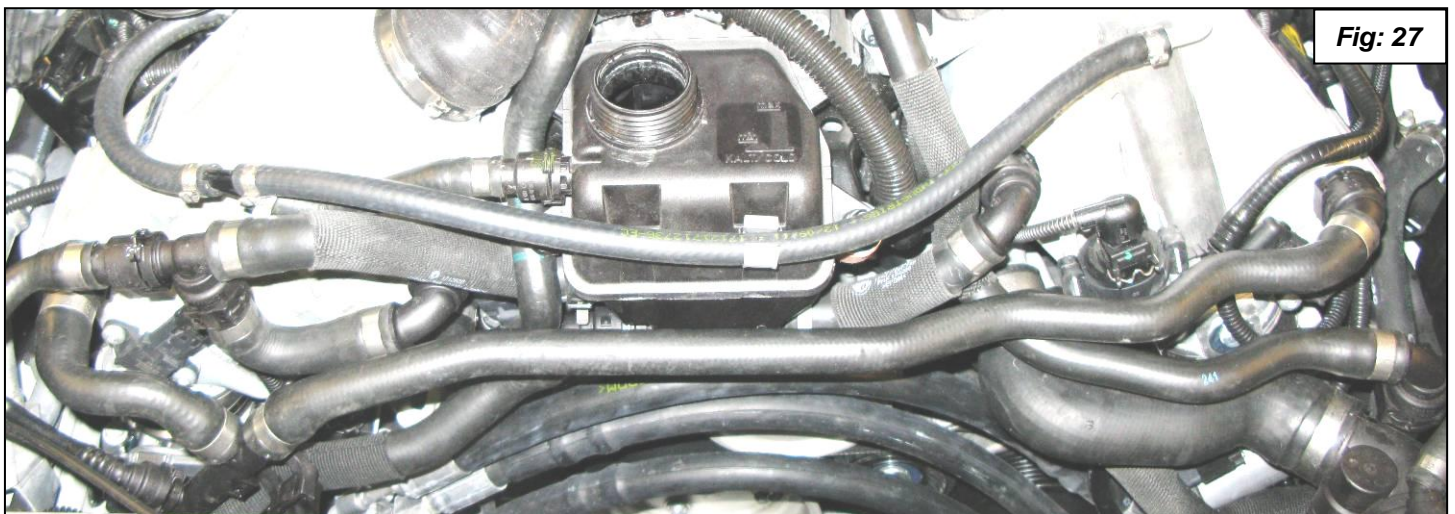


Fig: 27

25. Install the fan cowl with electric fan following BMW TIS instructions # 17 11 035.
26. After completing installation work, fill and vent the intercooler coolant system following BMW TIS instructions linked to the removing stock intercooler instructions BMW TIS procedure # 17 51 001.
- Venting cooling system:**
- Note:* Do not leave the coolant expansion tank cap open during the venting procedure.
- a. Add coolant up to top edge of expansion tank. Coolant must not drop any further! No drop in coolant for approx. 1 minute.
 - b. Connect battery charger.
 - c. Switch on ignition.
 - d. Set heater to maximum temperature. Press "Automatic" button, then reduce fan to lowest setting.
 - e. Press accelerator pedal for 15 seconds to floor. **Engine must not** be started.
 - f. The venting procedure is started when the accelerator pedal is pressed and takes approx. 12 minutes.
 - g. Refill expansion tank up to top edge immediately after drawing off until empty.
 - h. Adjust expansion tank to maximum level at end of venting process.
 - i. Check cooling system for leaks.
 - j. Close expansion tank.
 - k. If the venting procedure has to be carried out again, allow DME to drop completely (ignition key removed for approx. 3 minutes), then repeat from step "e".

27. Enjoy!