

#TL100106



MQB STAGE III EFR TURBO SYSTEM/
INSTALLATION INSTRUCTIONS

APR

Notes:

These instructions were written for a North American specification MkVII GTI and Golf R. Other models, like the Audi A3, are similar.

When disassembling the car, be sure to keep all fasteners so they can be reused. It is recommend that you get some kind of compartmented tray to organize the fastners, such as a fishing tackle box or several large ice cube trays. Fasteners that are not reused for reinstallation are noted in the instructions. All directions used in this manual (right, left, front, etc.) are based on if you were sitting in the drivers seat of the car.

These instructions assume that you have basic mechanical skills and several varieties of the tools of basic hand tools in order to install the kit. If you have any questions about the install, feel free to contact your APR representative.



WWW.GOAPR.COM

4800 US HWY 280 West Opelika Alabama 36801

TL100106 |

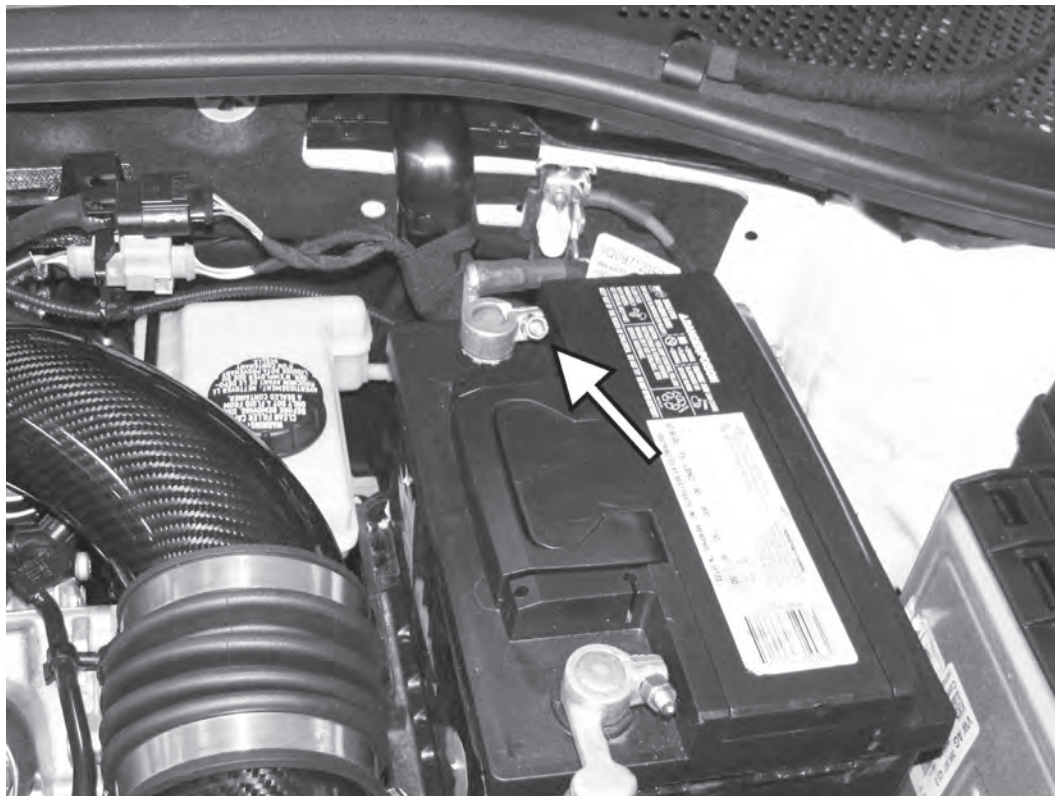

1) Disconnect the 10mm negative battery terminal and set aside. Remove the engine cover from the top of the engine by lifting up on the corners of it.

2) Securely lift vehicle. If a vehicle lift is not used, secure the vehicle with jack stands. Remove both front wheels.



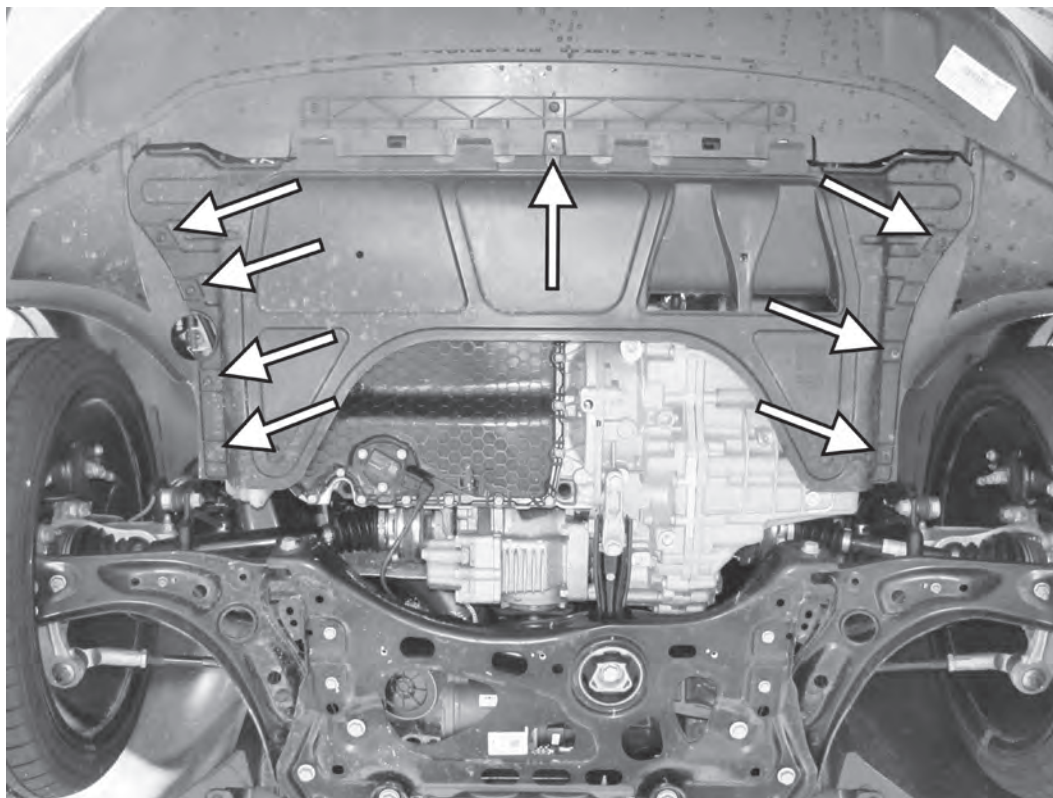

3) Remove the eight T25 screws from the engine belly pan, and remove the belly pan from the car. Note how the belly pan snaps into the lower portion of the front bumper cover.

4) Remove the screw holding the APR intake to the back side of the radiator core support. Slide the intake towards the left side of the car to separate it from the core support.



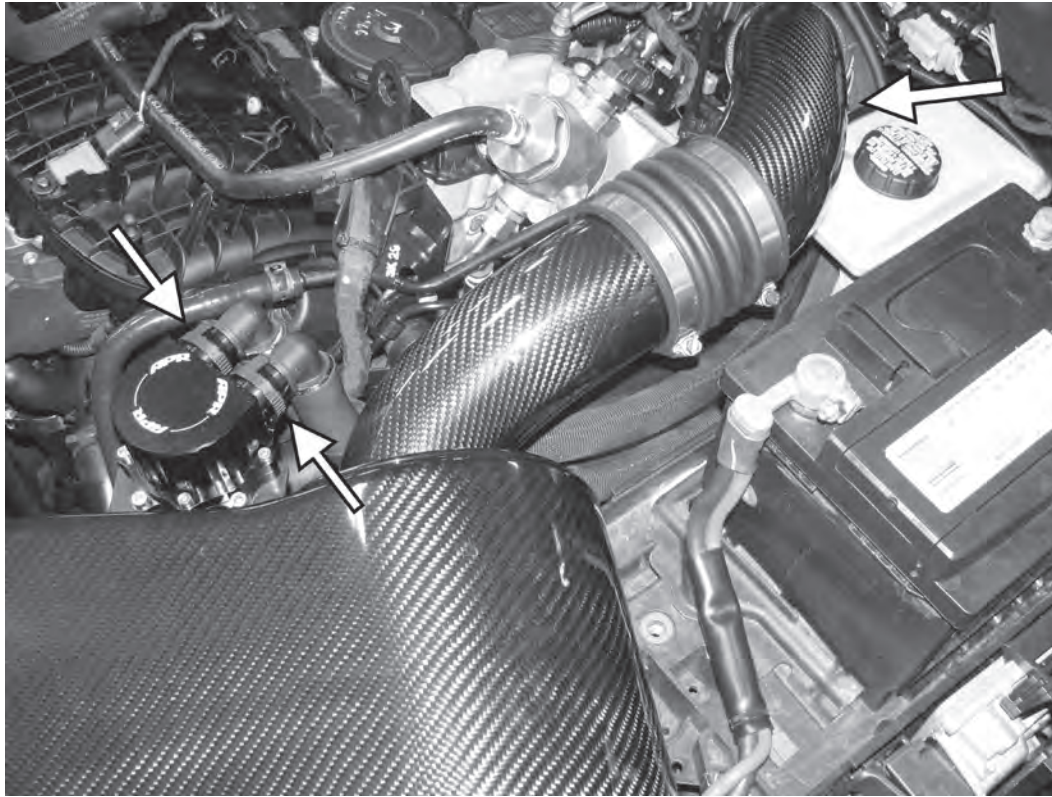

5) Loosen the clamp holding the APR intake to the rear intake coupler, closest to the turbocharger. If equipped, disconnect the two fittings from the APR catch can hoses to the APR catch can. Disconnect the vacuum line from the bottom of the APR intake and remove the APR intake with catch can attached from the car.

6) Remove the T30 screw from the side of the factory turbo outlet pipe. Unhook the wiring harness from the turbo outlet pipe. Remove the hose clamp connecting the turbo outlet pipe to the turbocharger outlet coupling hose. Finally, pull the turbo outlet pipe off and away from the turbocharger.



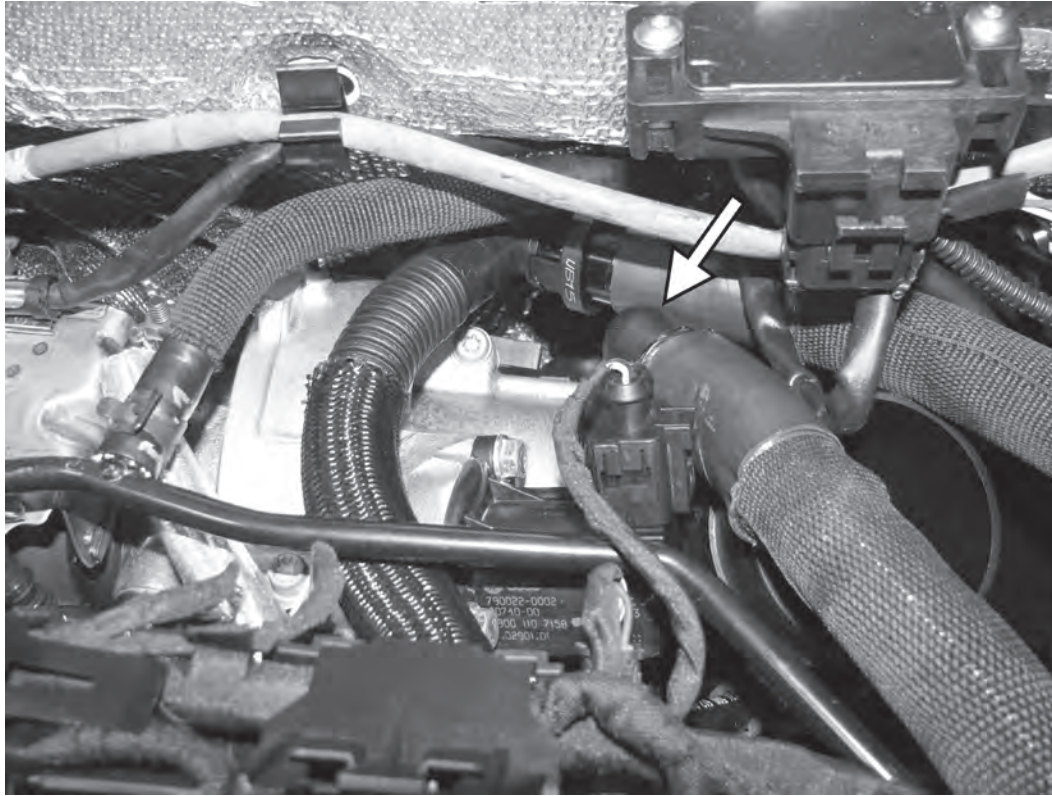

7) Disconnect the PCV vent hose from the top of the turbocharger, or if equipped, the APR catch can return line from the top of the turbocharger.

8) Separate the oxygen sensor wiring harness from the clip on the back of the heatshield. From the back of the factory turbo heatshield, remove the four 8mm triple square bolts and one 10mm nut holding the heat shield to the cylinder head, and remove the heatshield from the car.

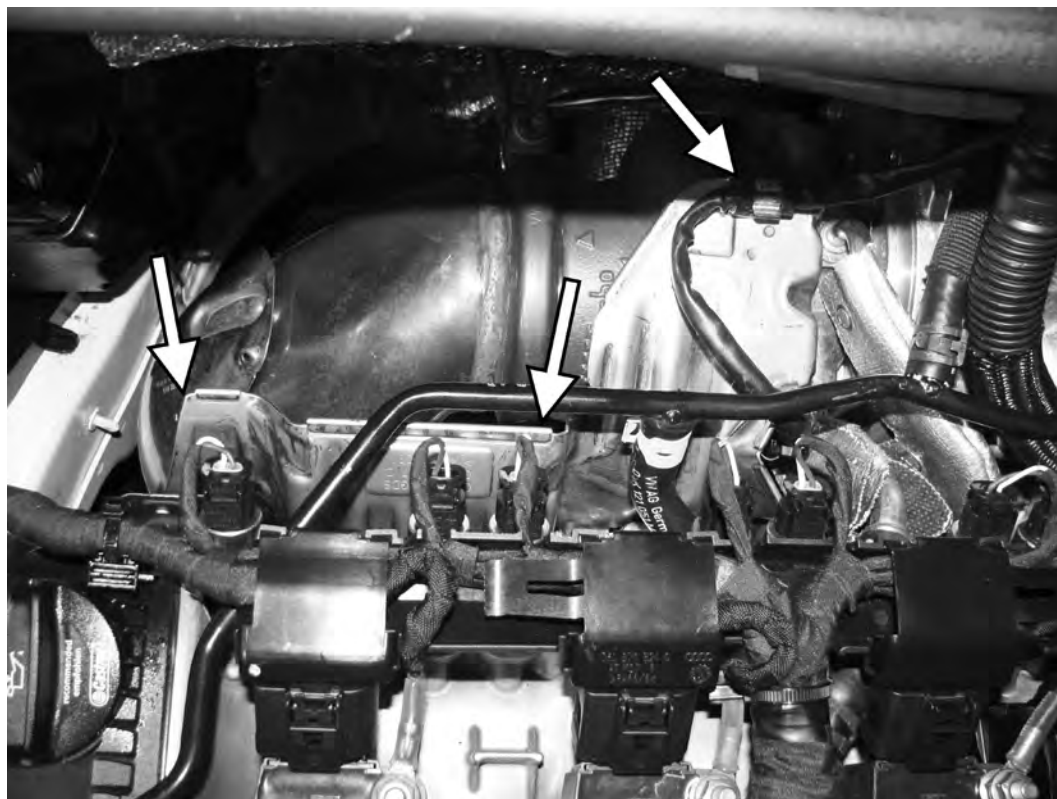

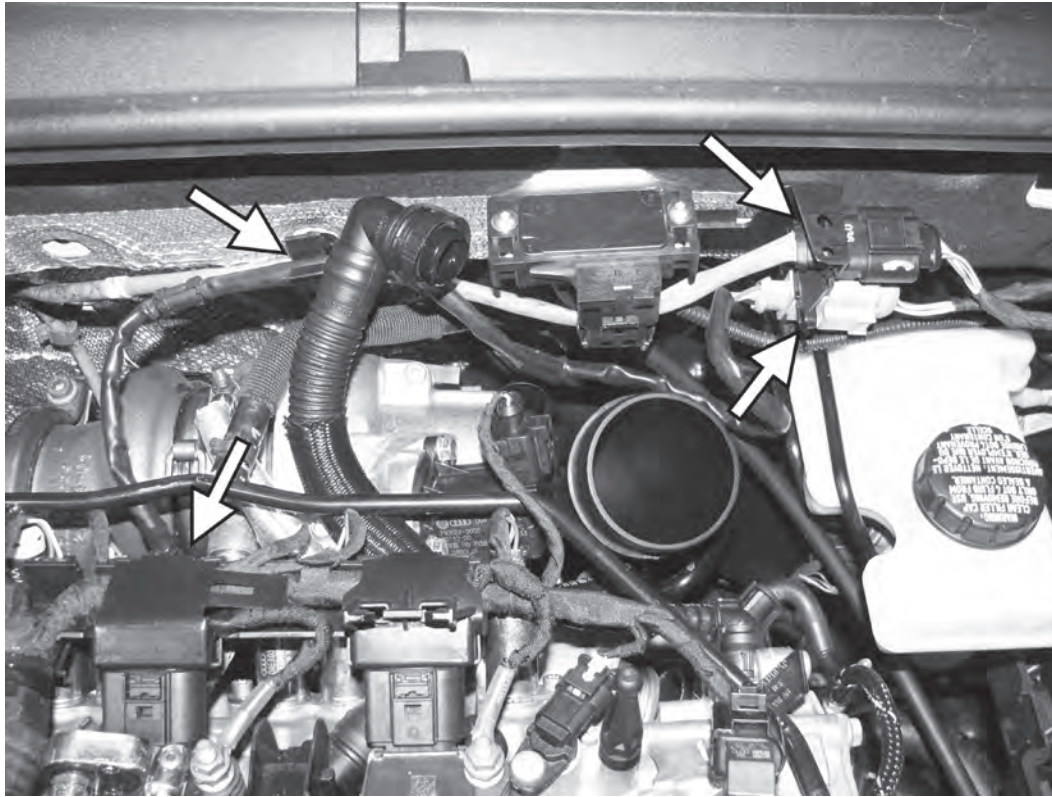

9) Separate both oxygen sensor electrical connectors from the mounting bracket on the firewall and disconnect the sensors. Separate the primary oxygen sensor wiring harness from all mounting connections, and remove the oxygen sensor from the turbo with an oxygen sensor socket.

10) Loosen the 6mm allen screw holding the downpipe V-band clamp from the downpipe. Remove the V-band clamp from the car.



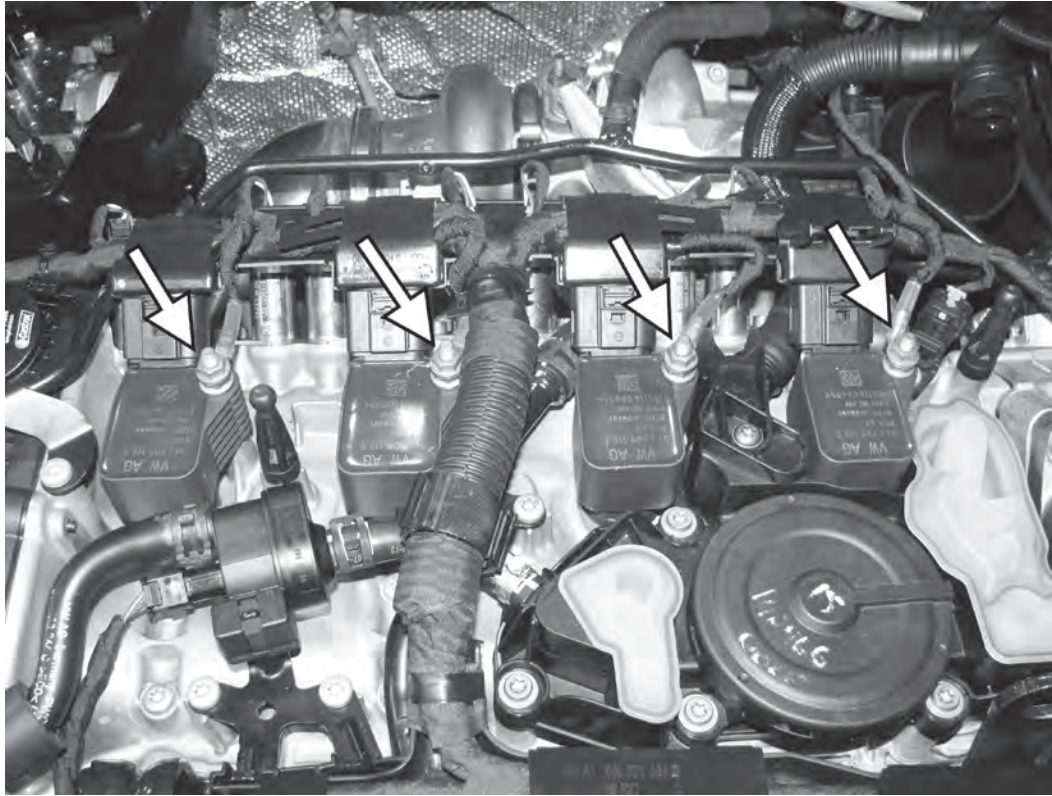

11) Remove the four 10mm nuts holding the grounding straps to the ignition coilpacks, and separate the grounding straps from the mounting posts. Once the ground straps are removed, remove the 10mm bolts holding the coilpacks in place.

12) Disconnect the four electrical connectors to the coilpacks, and lift the wiring harness off the coilpacks. Lift up on the coilpacks, and remove all four from the car.

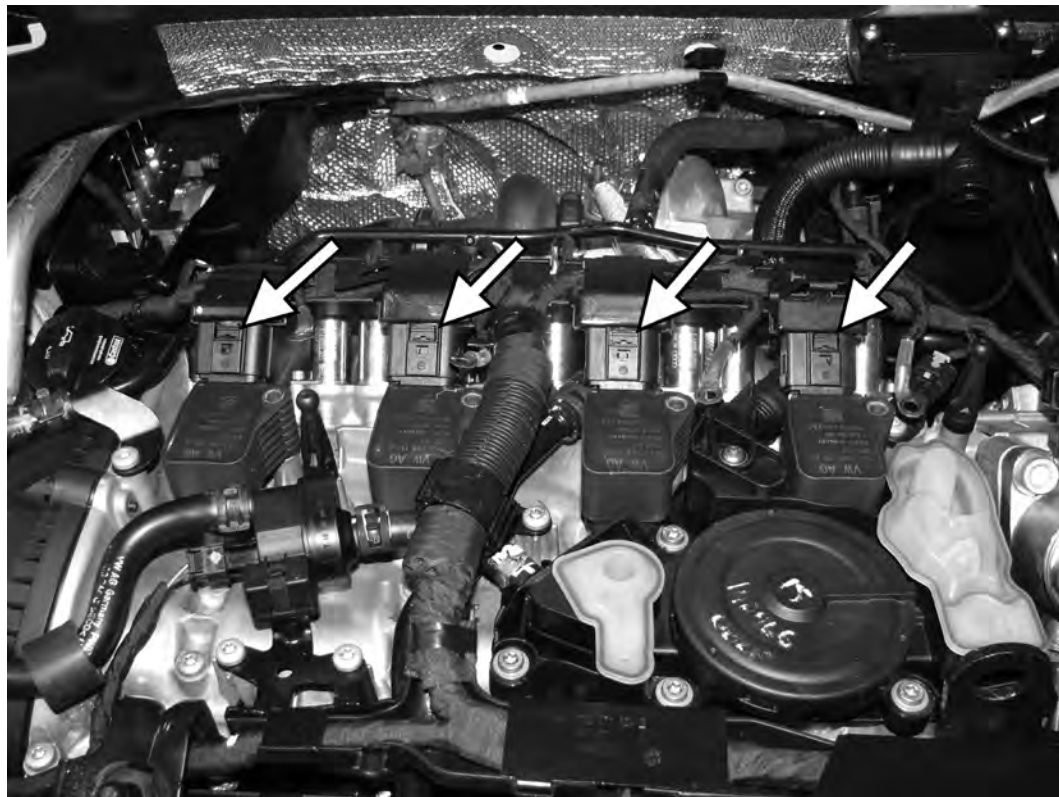

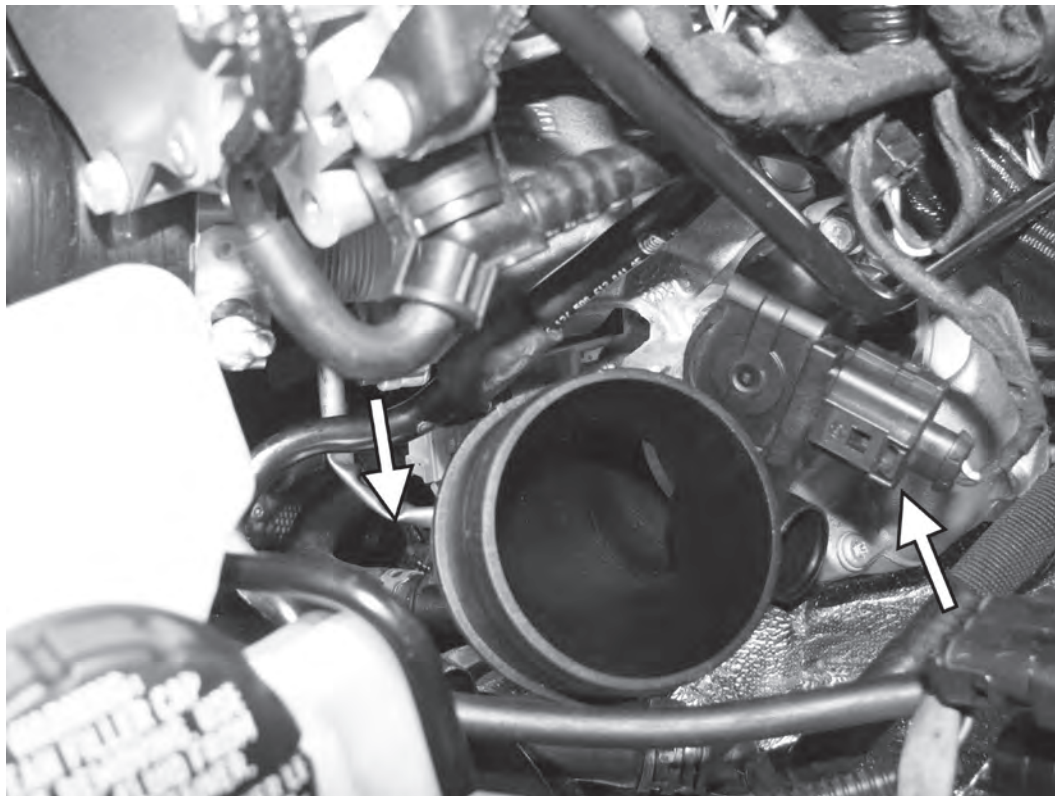

13) Disconnect the electrical connectors from the diverter valve and the electronic wastegate actuator.

14) Inside the footwell of the car, remove the two plastic flathead screws from the plastic cover behind the pedals, and remove the cover to access the steering column.



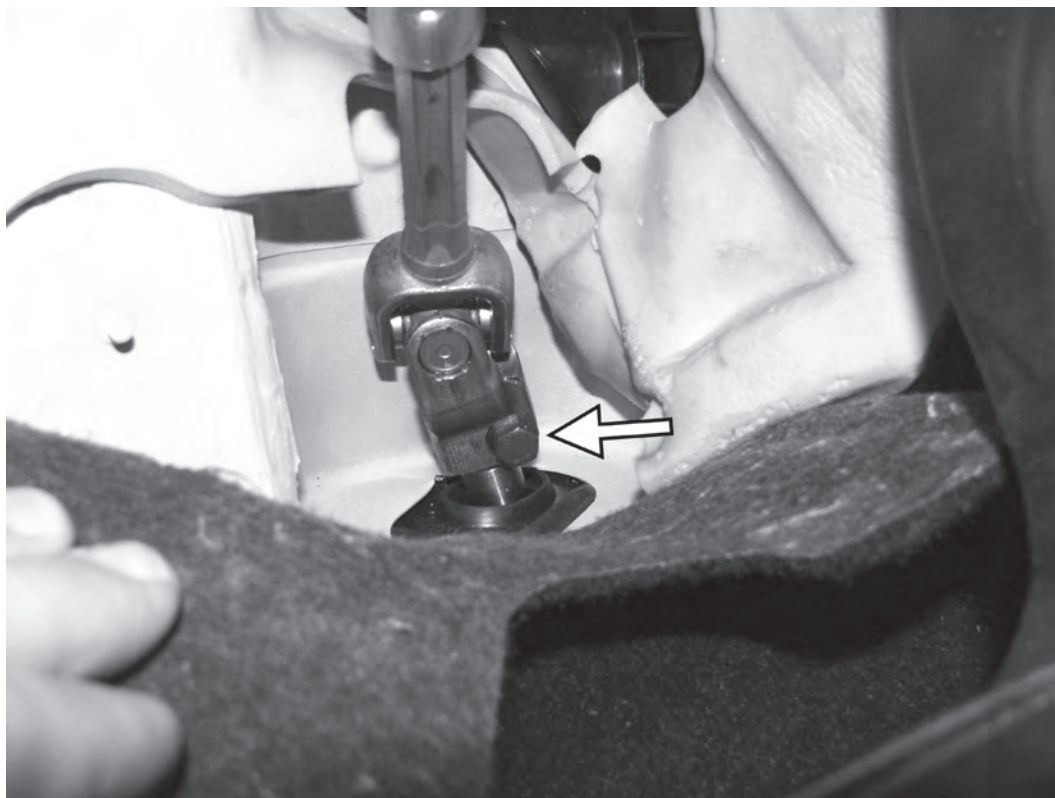

15) Remove the 13mm bolt holding the steering column to the steering rack.

16) Remove the four 13mm bolts from the back of the rear subframe mounting brackets. Remove the two 18mm bolts from the front of the rear subframe mounting brackets, and remove the brackets from the car.

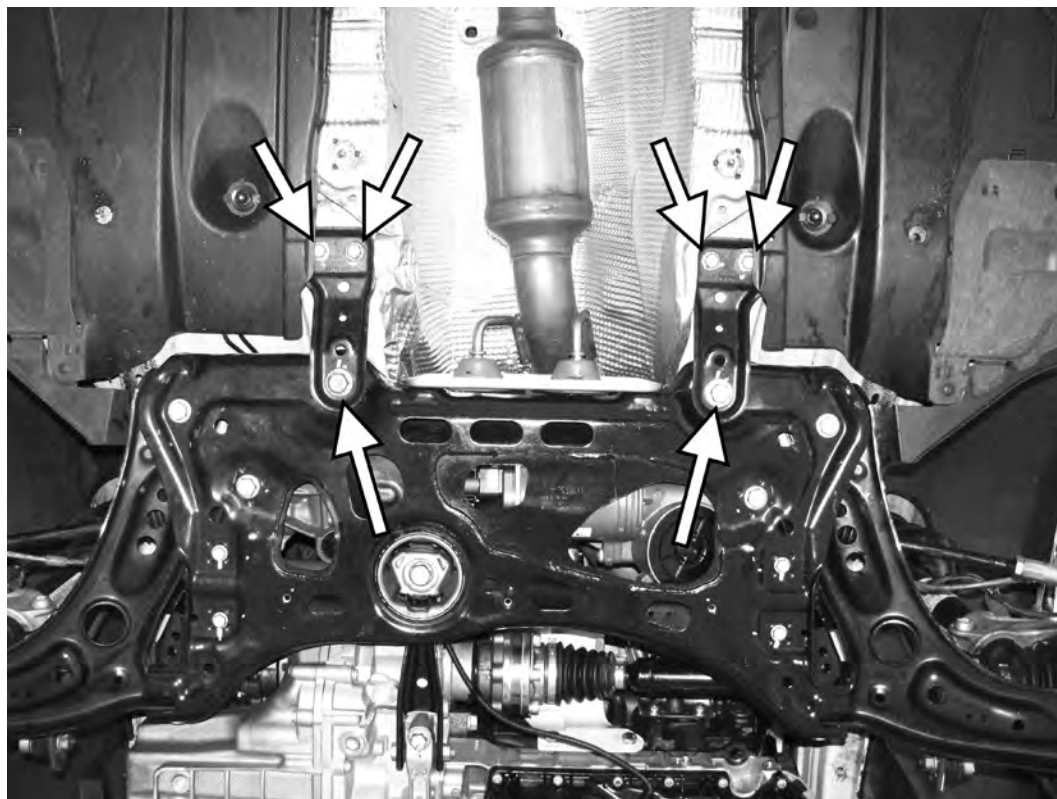

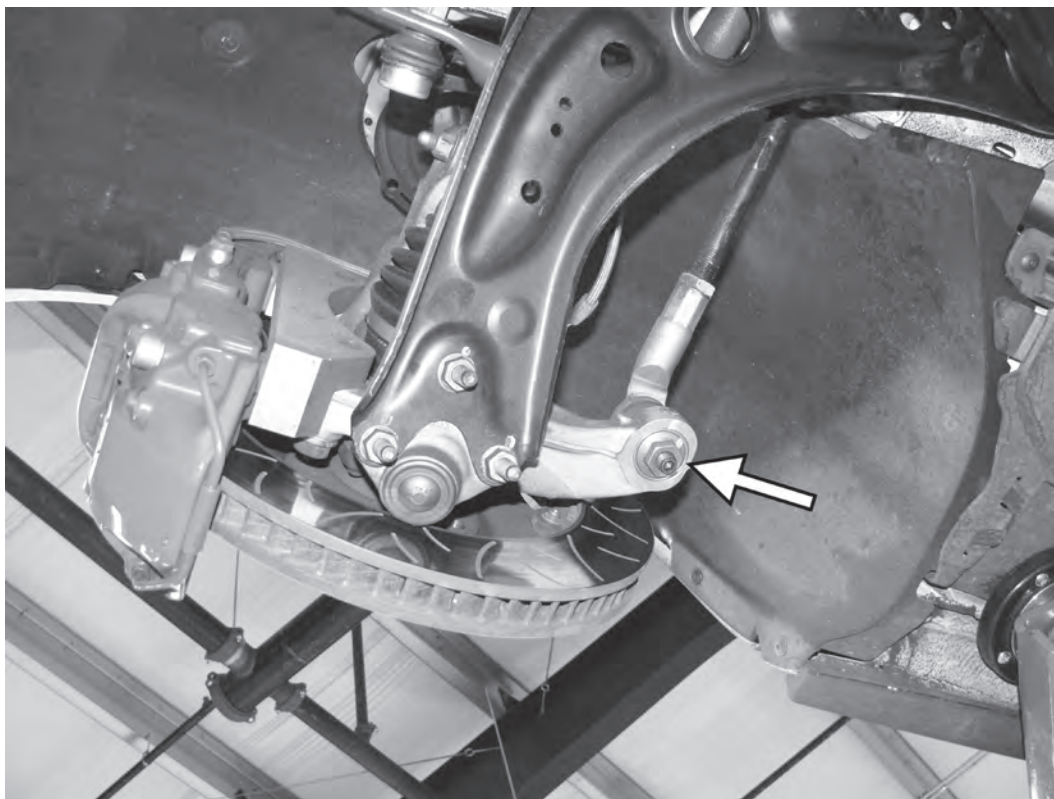

17) Remove the two 21mm nuts holding the tie rods to the uprights on both sides of the car. Separate the tie rod from the upright. If necessary, lightly tap on the side of the upright with a brass hammer to help break the tie rod free.

18) Remove the six 16mm nuts holding the ball joint to the lower control arm on both sides of the car. Separate the ball joints from the lower control arms by simply lifting up on the upright. If equipped, disconnect the headlight level sensors from the lower control arms by removing the 10mm nut. Also unplug the electrical connector from the top of the level sensors.

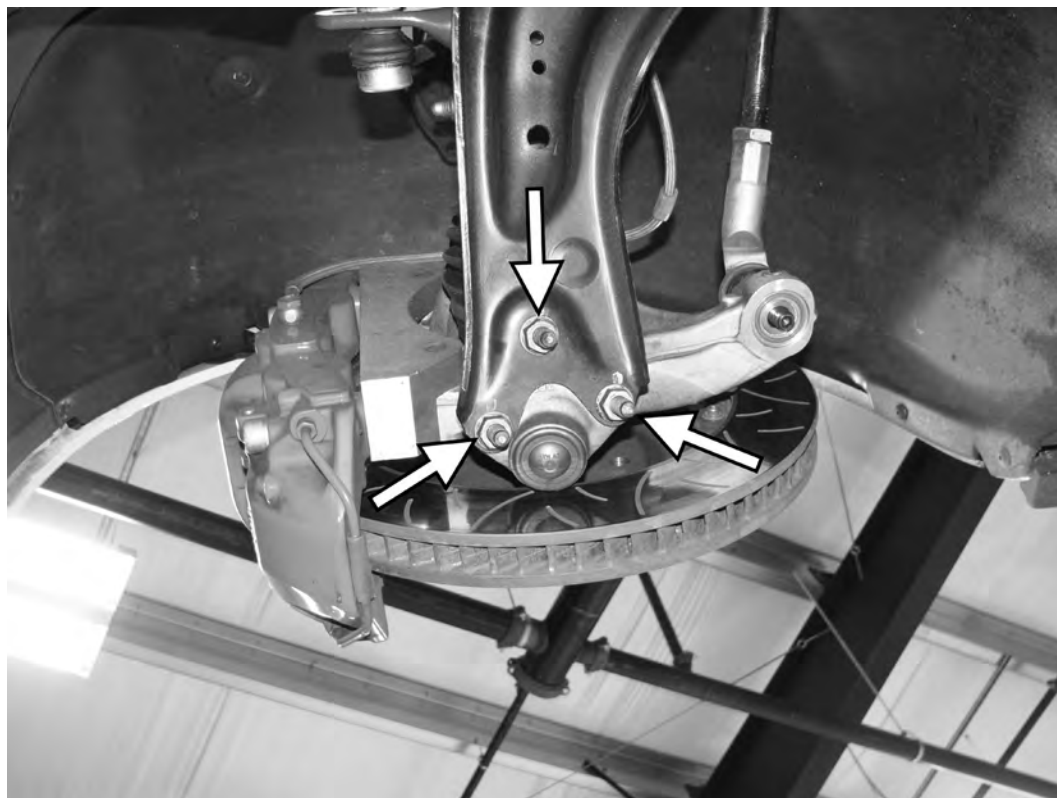

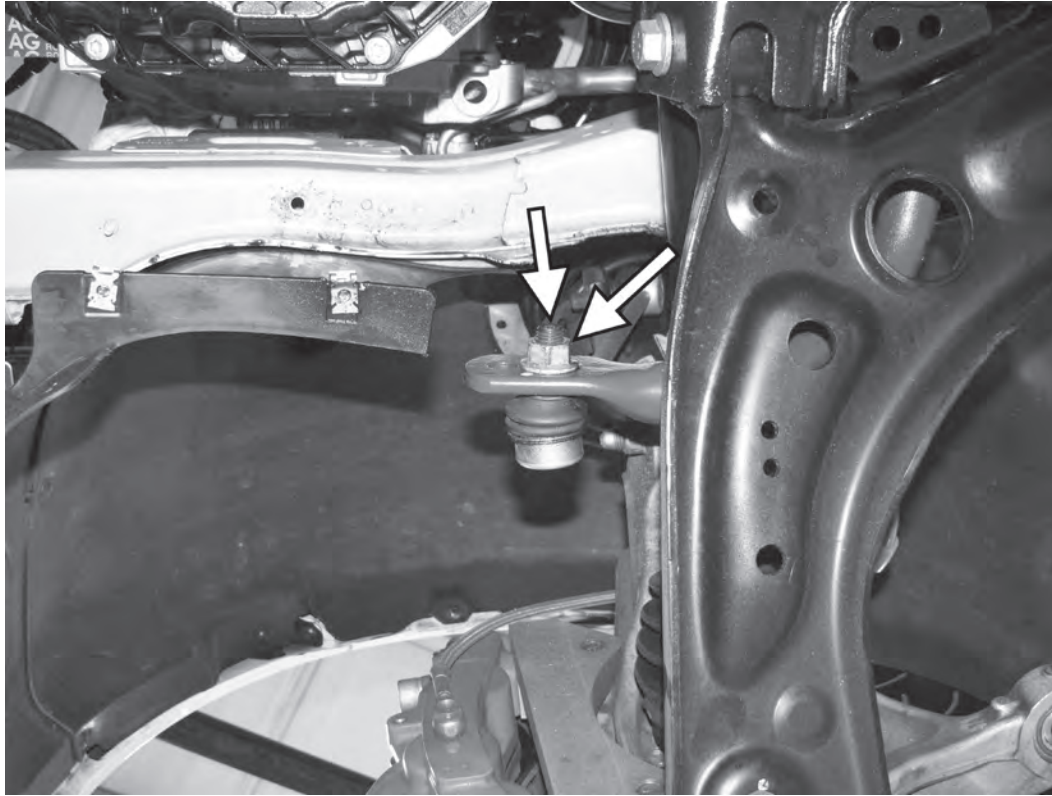

19) Use an 18mm wrench to separate the sway bar end link. If necessary, counterhold the end of the screw with a 6mm triple square.

20) Remove the two 13mm bolts holding the downpipe support bracket to the subframe.

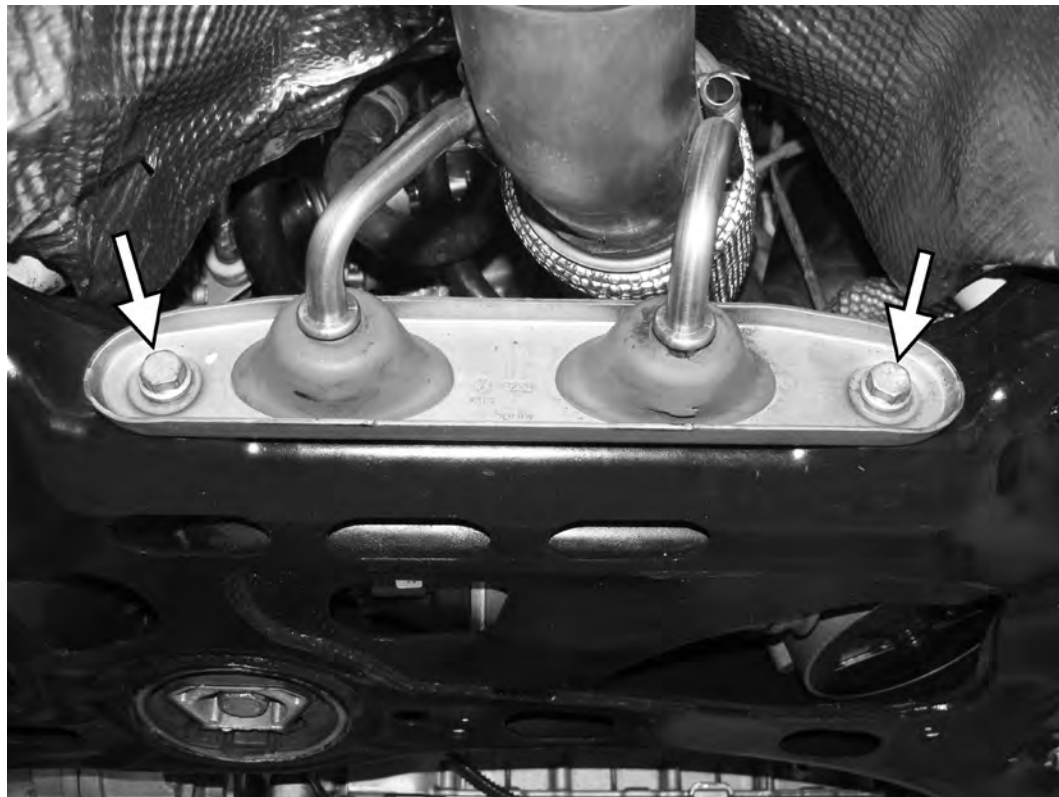

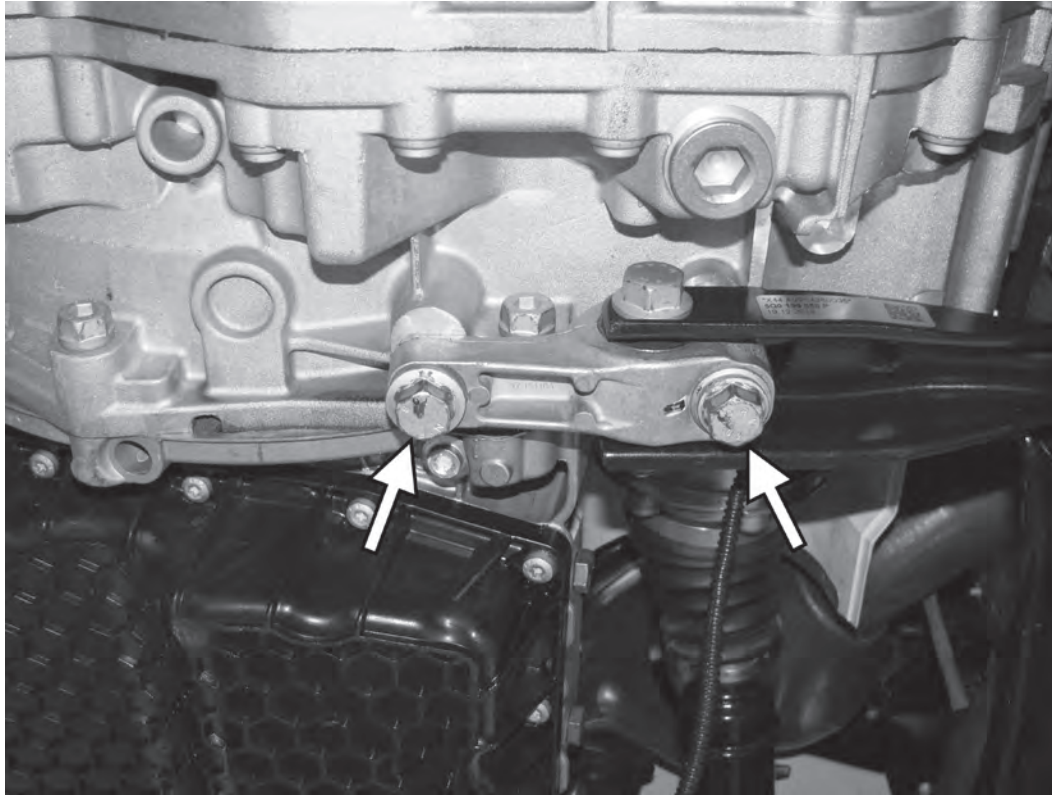

21) Remove the two 16mm bolts from the front side of the lower engine mount.

22) Support the subframe with a transmission jack.



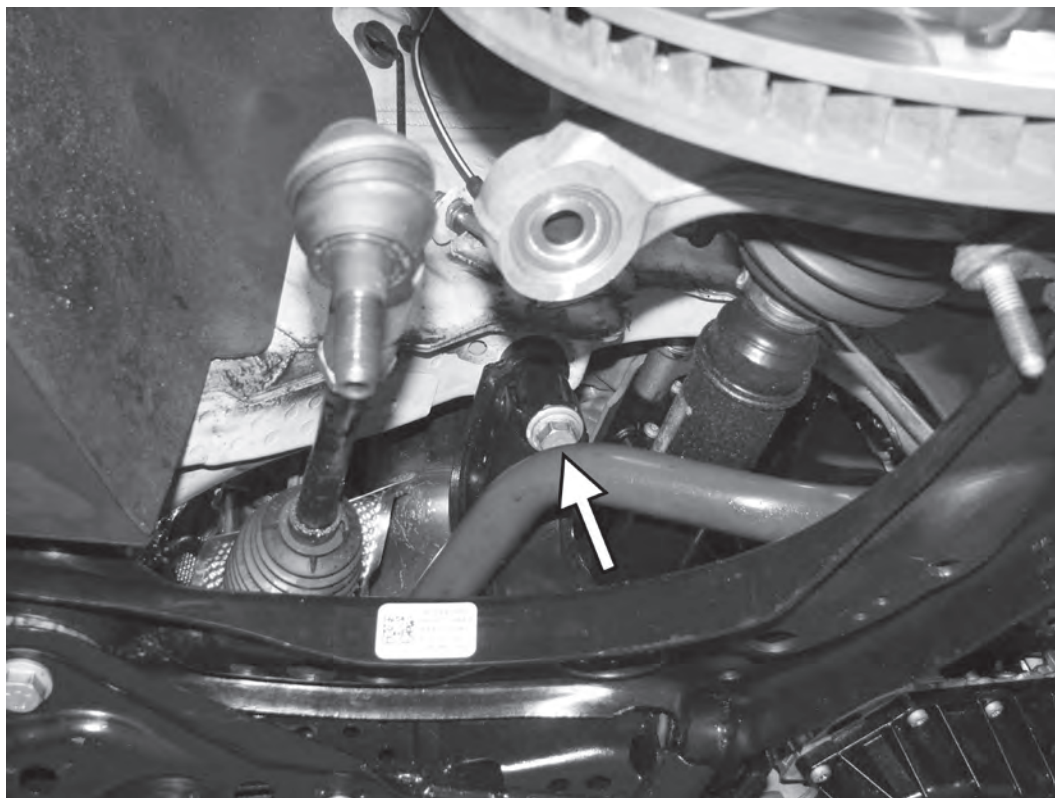

23) Remove the two 18mm bolts where the upper subframe meets the frame rail. As you remove these bolts, the subframe will slightly lower.

24) Unplug the electrical connector to the oil level sensor on the bottom of the oilpan. Unclip the harness from its two mounting points on the transmission.

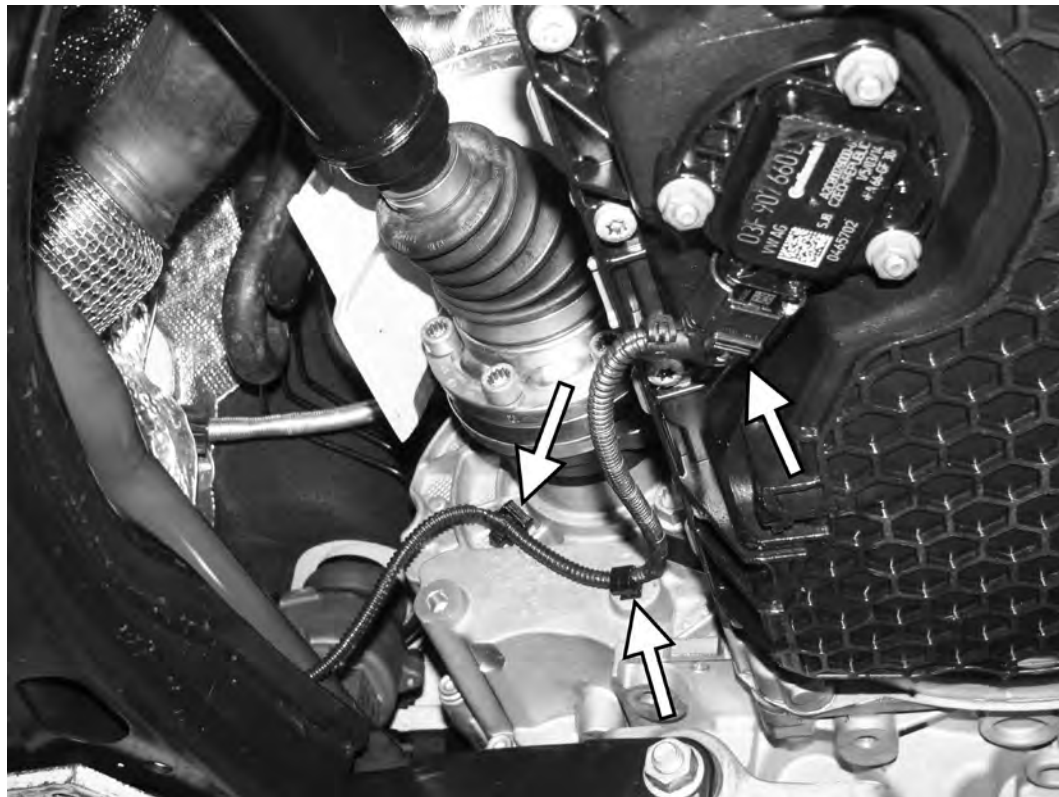

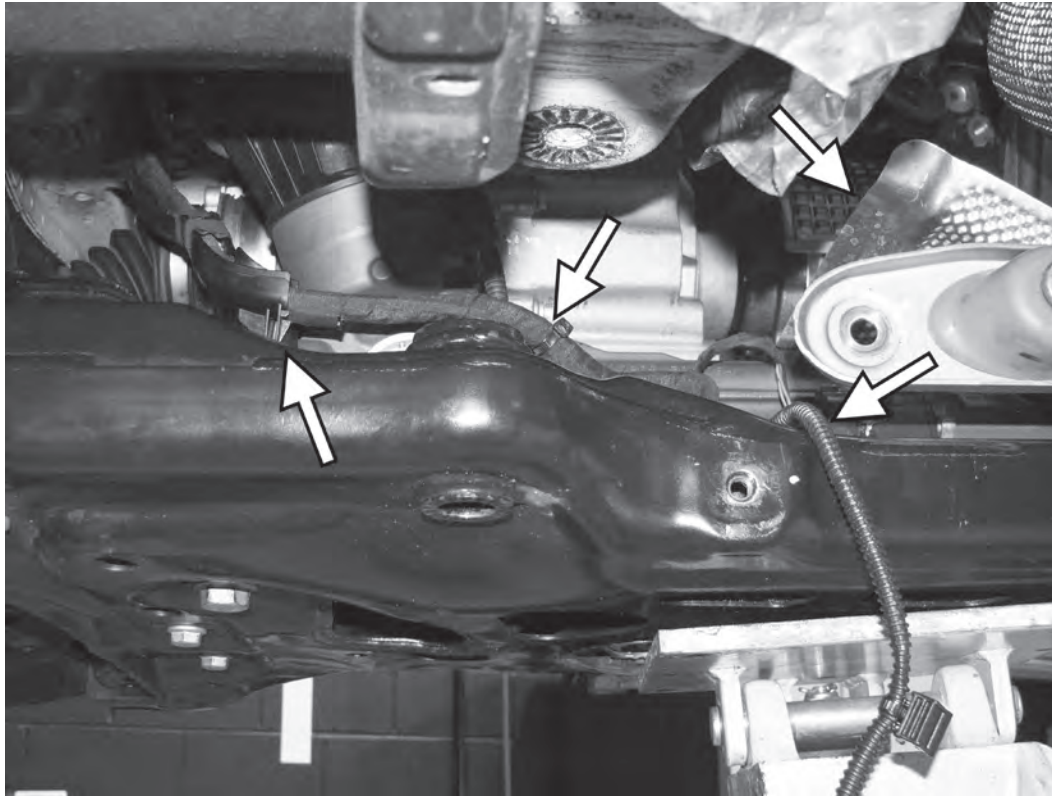

25) Lift and bend the heatshield on top of the steering rack, and route the unplugged oil level sensor harness to the back of the subframe. Disconnect the two harness retaining clips that hold the wiring harness to the steering rack/subframe assembly.

26) Disconnect the two electrical connectors from the top two plugs on the steering rack. Do NOT disconnect the connector on the lower steering rack position sensor.

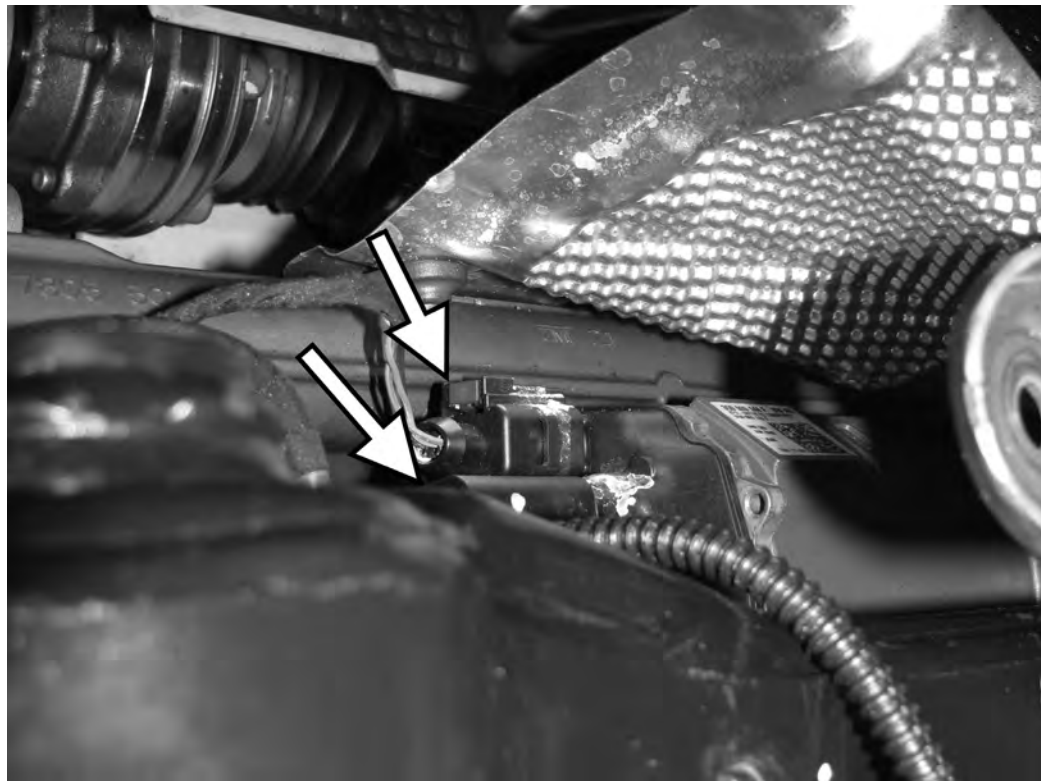

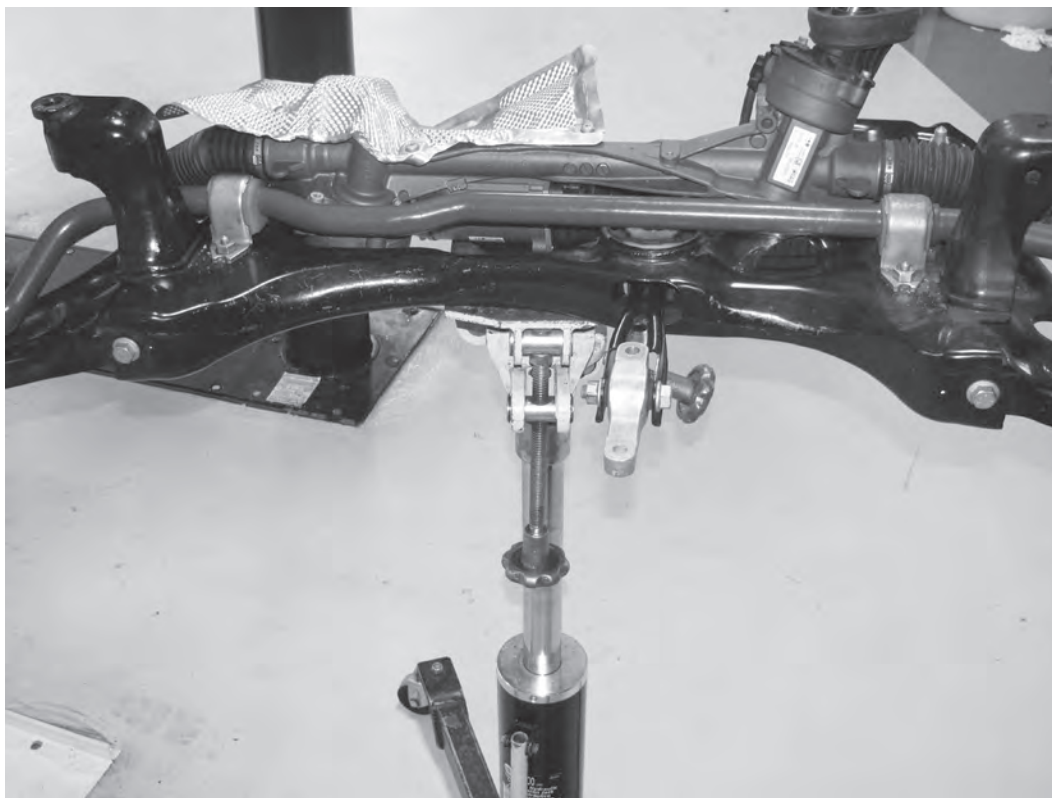

27) Carefully lower the subframe from the car, and push the subframe out of the way.

28) Loosen, but do not remove, the two 13mm nuts holding the factory catalyst to its support bracket.

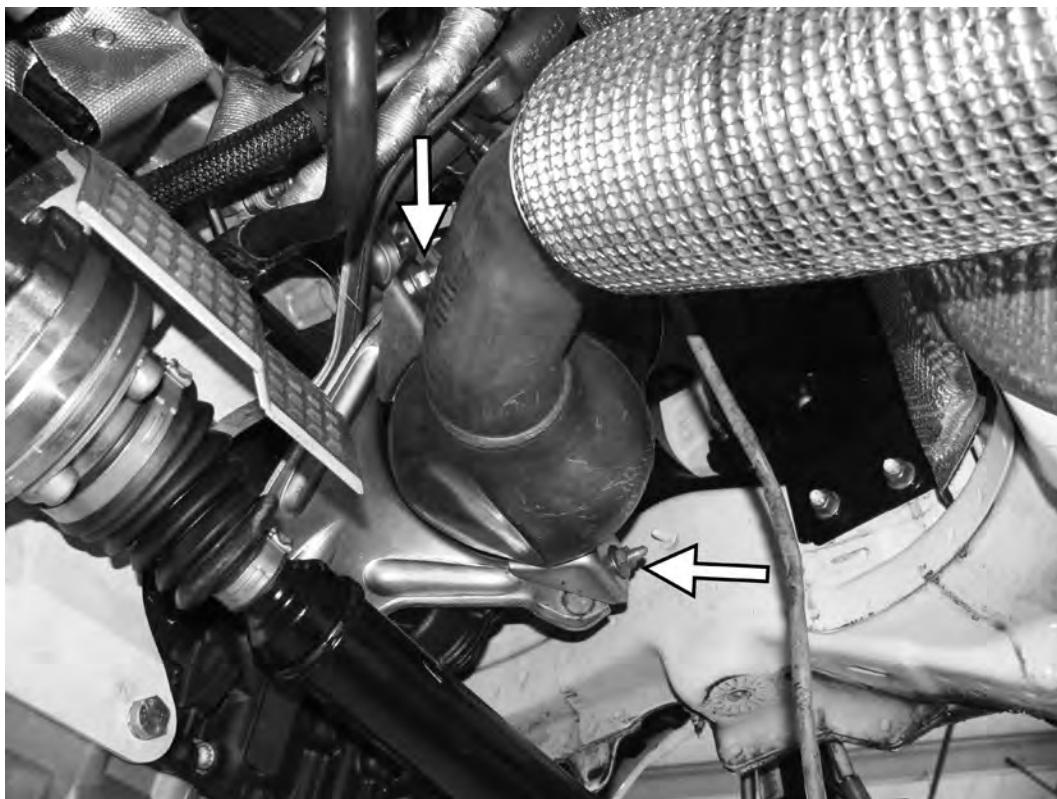

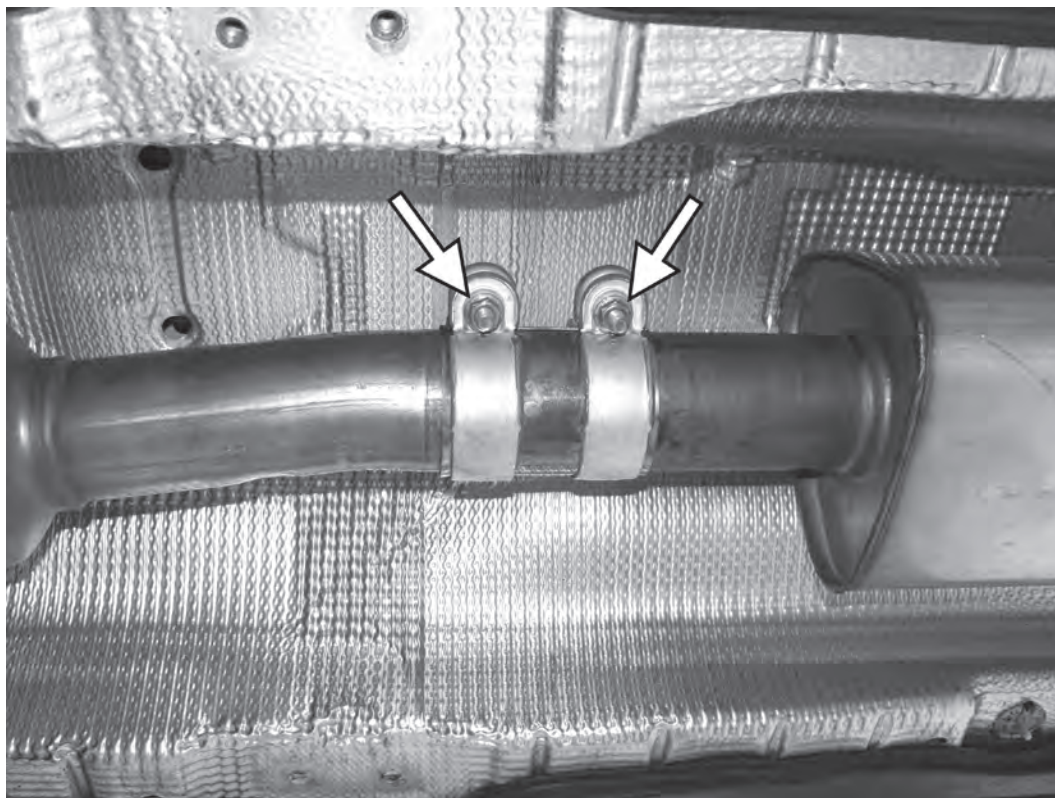

29) Loosen the two 13mm nuts from the exhaust clamp where the down-pipe connects to the rear portion of the exhaust.

30) Slide the exhaust clamp off the back of the downpipe, support the downpipe, and remove the two 13mm nuts from the downpipe support bracket. Remove the downpipe from the car.



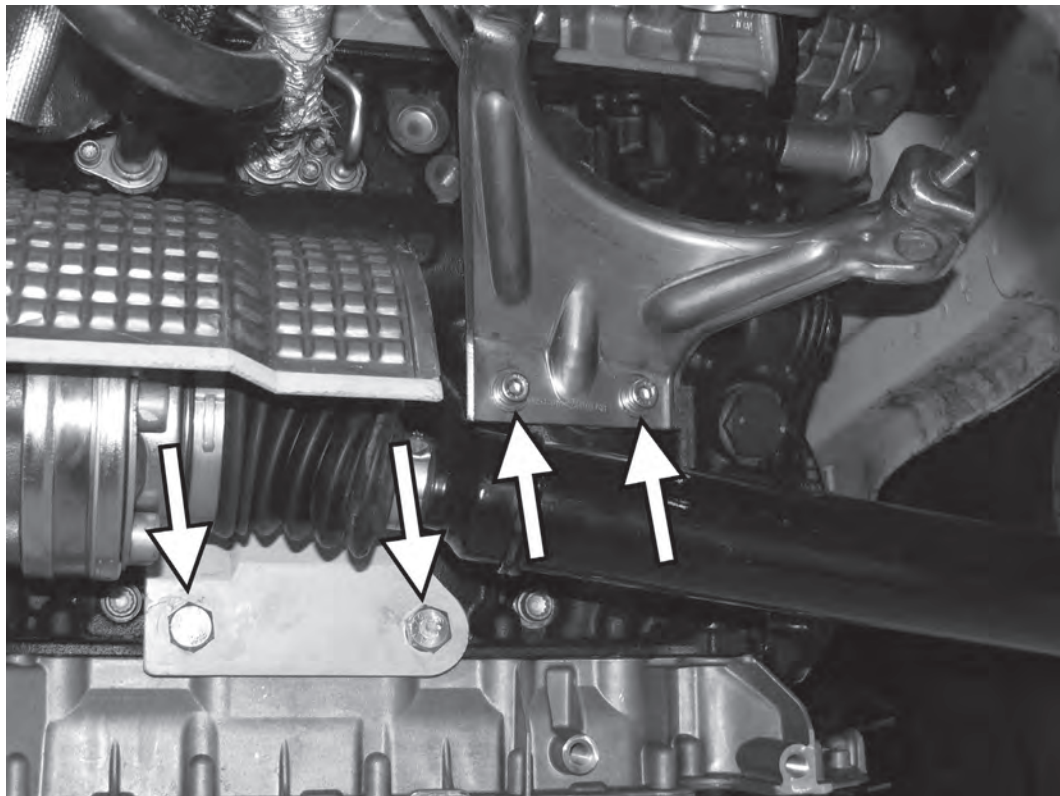

31) Remove the two 16mm bolts from the axle heat shield, and remove the heat shield from the car. Remove the two 6mm allen bolts from the catalyst support bracket, and remove the bracket from the car.

32) Remove the 6mm allen bolt from the top of the turbo support bracket. Remove the 13mm bolt from the bottom of the support bracket, and remove the bracket from the car.



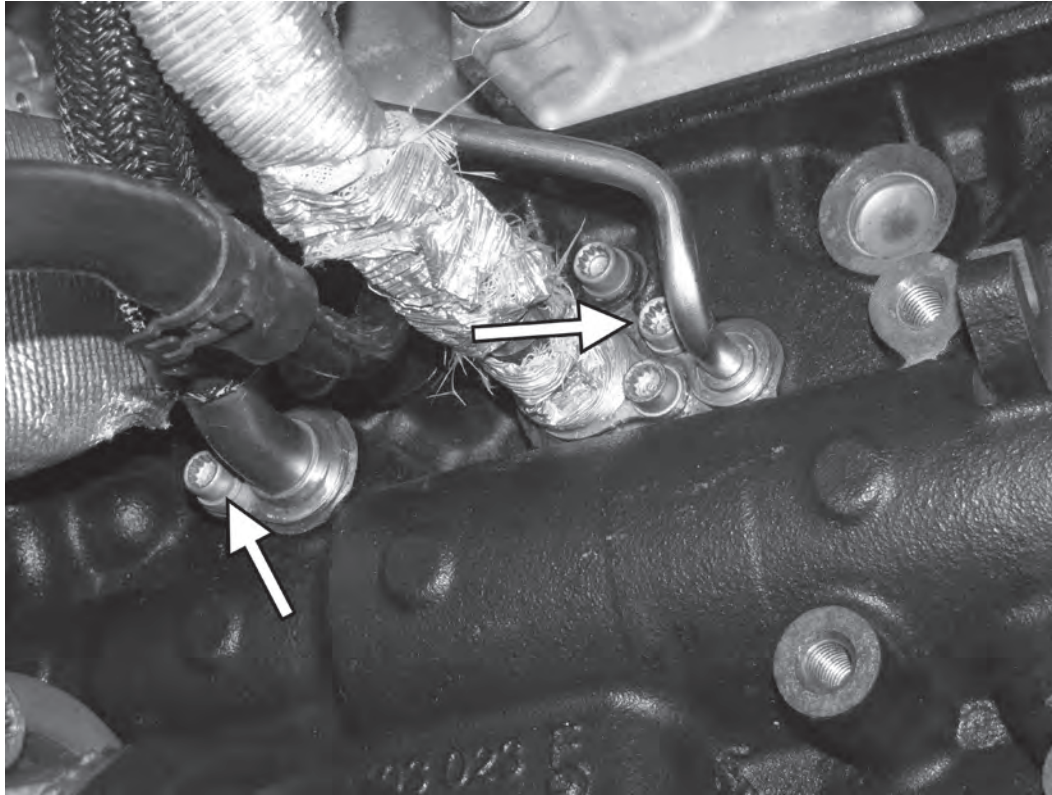

33) Remove the two 8mm triple square bolts from the oil drain and oil feed lines at the engine block. Pull the lines out of the block to drain the engine oil.

NOTE: On AWD cars, the turbo oil drain line on the left can be accessed above the bevel box with a long extension from the left side of the rear propshaft.

34) Remove the two 8mm triple square bolts from the coolant drain and coolant feed lines at the engine block. Pull the lines out of the block to drain the coolant. Both o-rings on these lines will be reused, so inspect them and replace if needed.

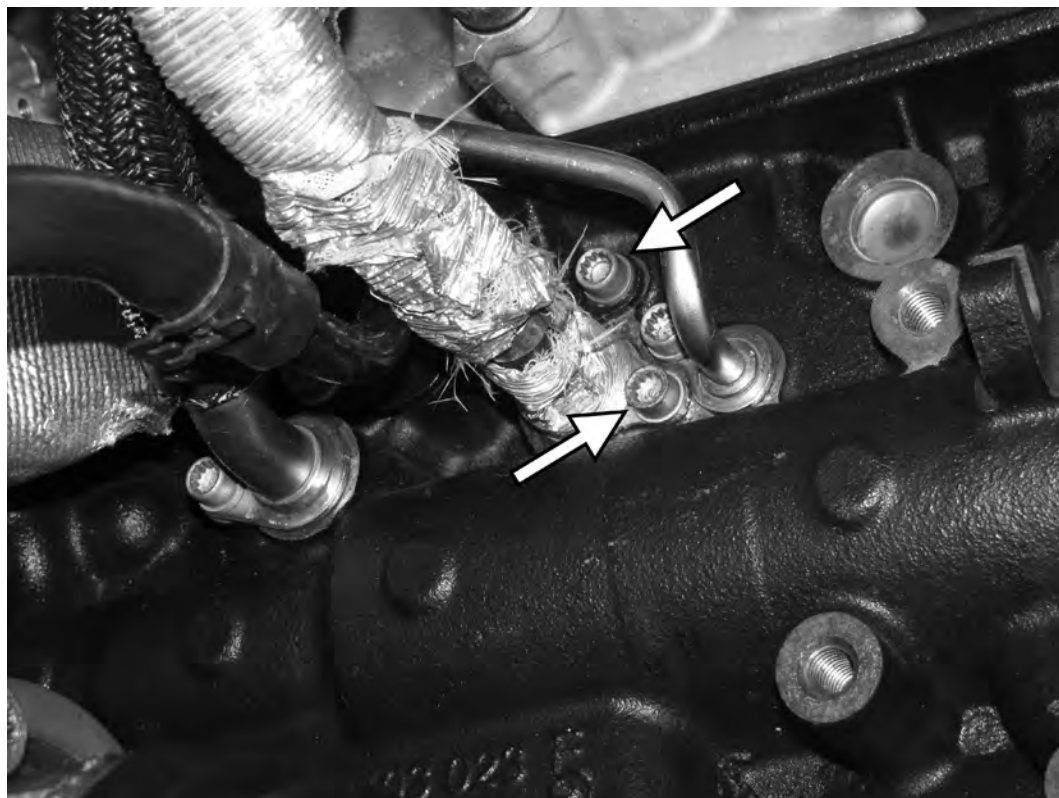

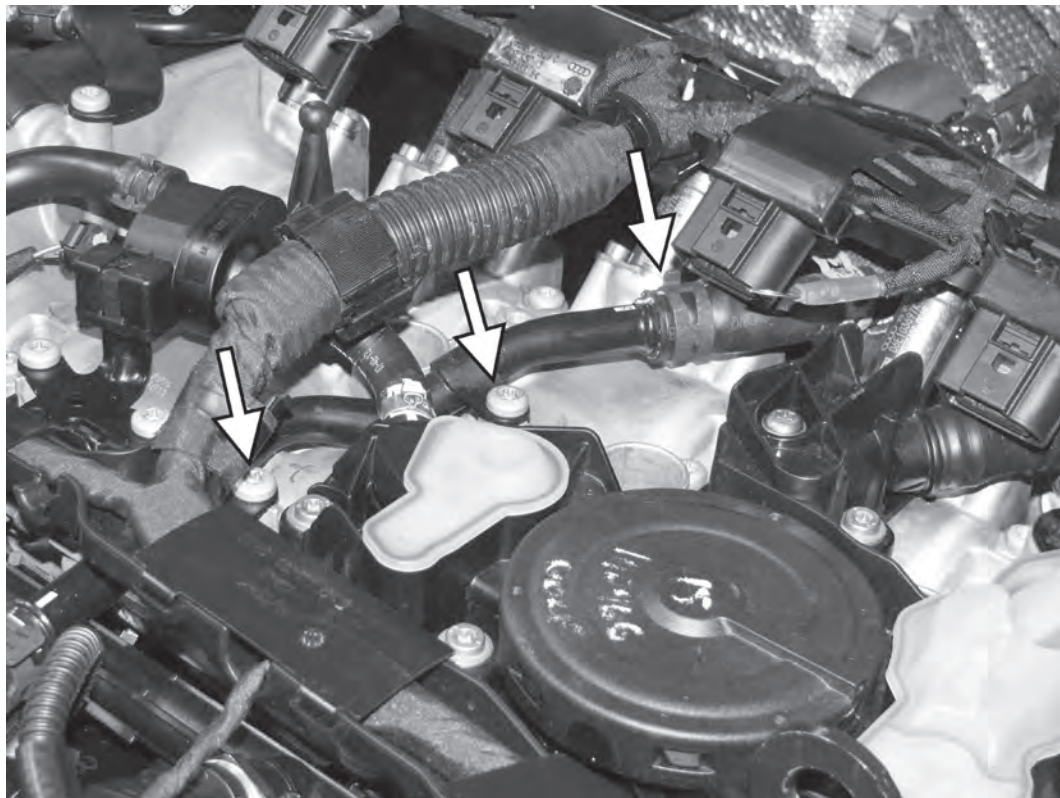

35) On the top of the engine, remove the two T30 bolts holding the coolant line to the top of the engine. Use hoseclamp pliers and remove the coolant line from the coolant pipe.

36) Remove the clamp from the coolant hoses where they enter the heater core at the back of the fire-wall. Remove the hard black pipe from the bottom of the factory coolant hose. This pipe will be reused.

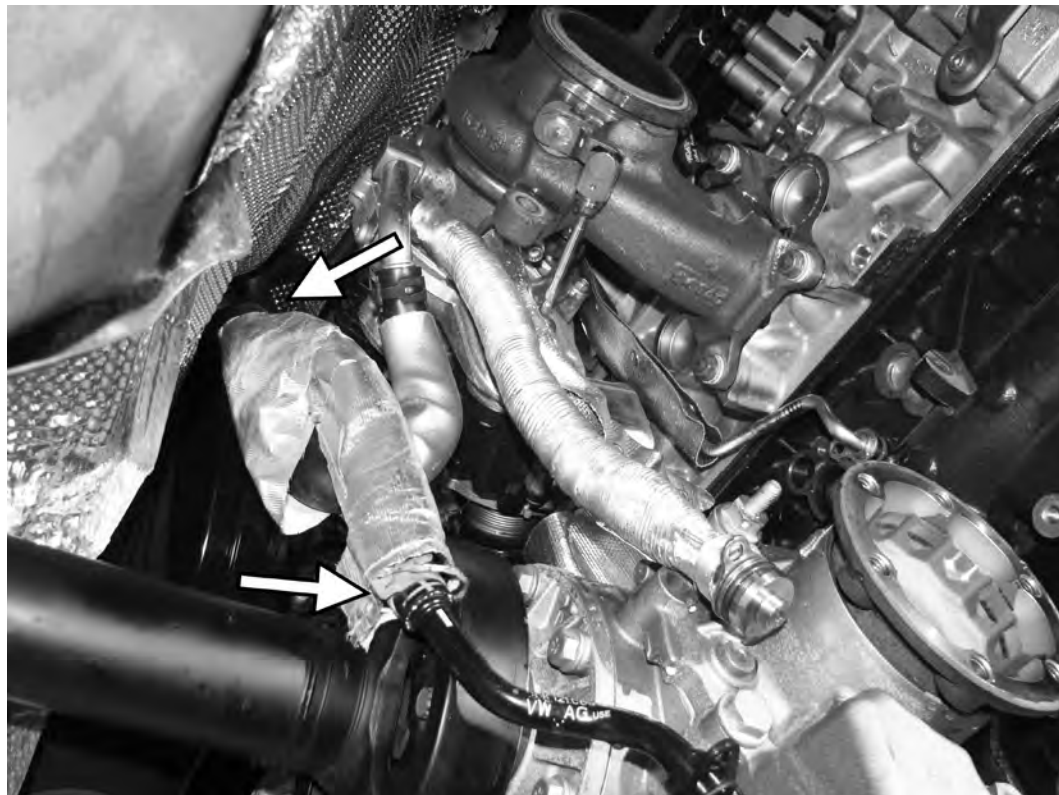

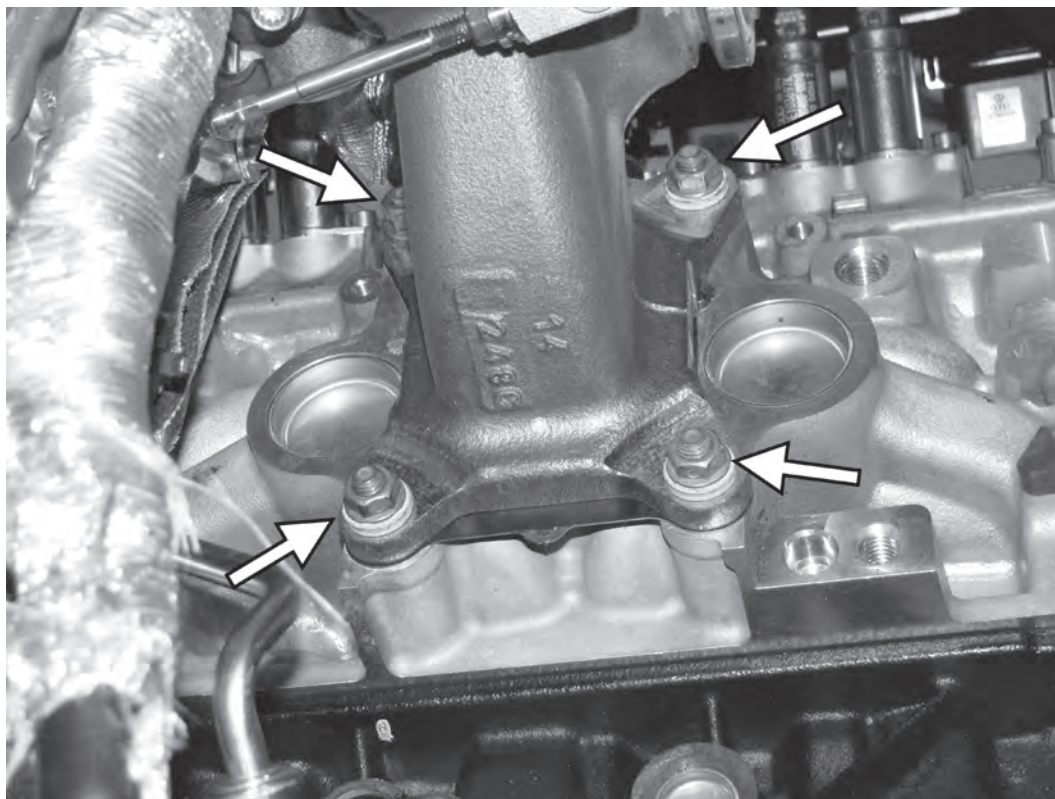

37) Remove the four 12mm nuts holding the turbo to the cylinder head. Remove the turbo assembly from the car.

38) Remove the stock turbo to cylinder head gasket.

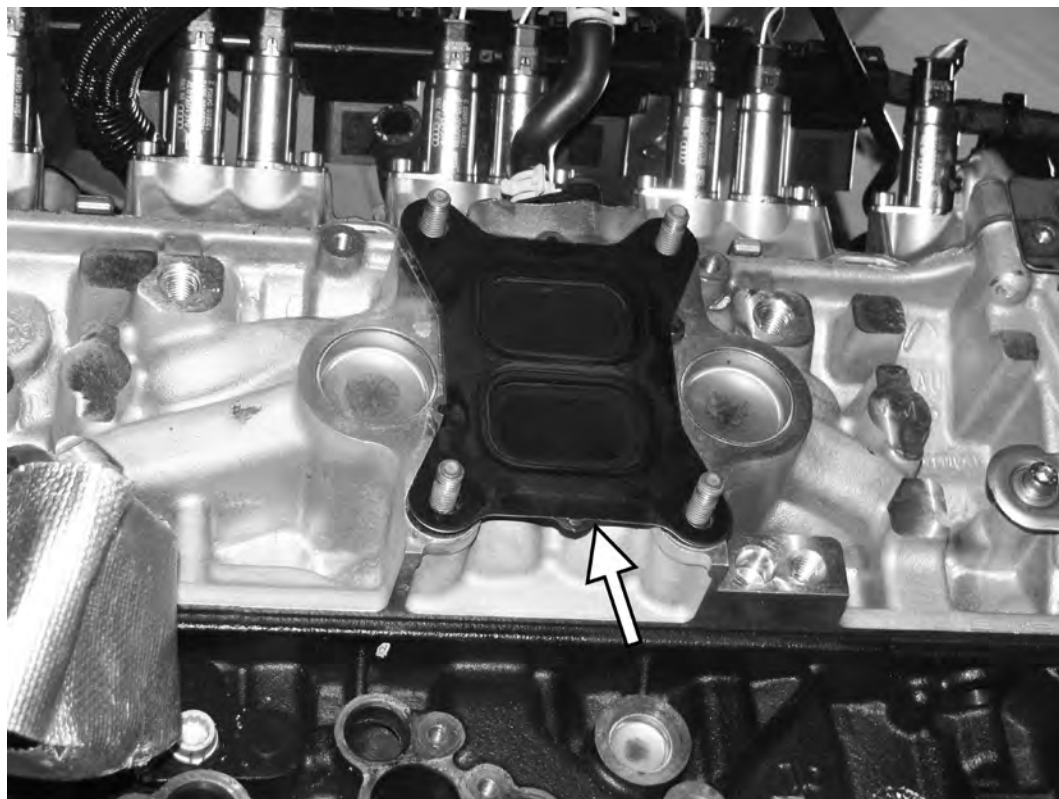

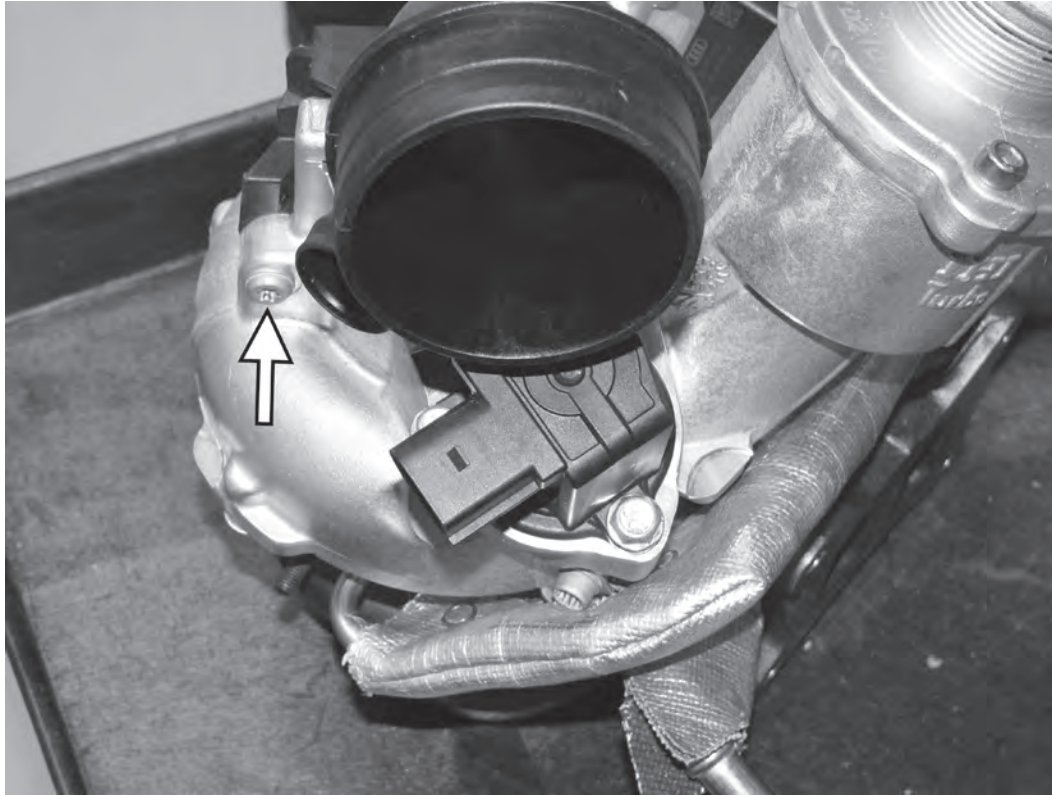

39) Remove the T30 screw holding the stock, plastic inlet pipe to the turbo. Rotate the inlet pipe ~45° clockwise, and then pull away from the turbo to remove the inlet pipe. Remove the diverter valve from the stock turbocharger.

40) Install the stock DV onto the APR turbo, making sure the DV is clocked so the electrical connector faces the N75 valve. The turbo also has a round mounting key where the face of the DV mates with it. Secure the DV with either the three stock screws, or the three supplied 10mm screws.

NOTE: On AWD cars, do not install the DV at this time.





41) Remove the plastic heat shield from the ABS brake pump that is located on the lower right side of the engine firewall. Cover the outside of the heat shield with the supplied heat reflective tape. Reinstall the cover to the ABS brake pump.

42) Install the new, supplied turbo to cylinder head gasket on the engine. Install the APR manifold to the engine as shown, with the outlet facing slightly upwards. Install the four supplied flat washers and four 13mm flexloc nuts. Torque the flexloc nuts to 25Nm (220in-lb).

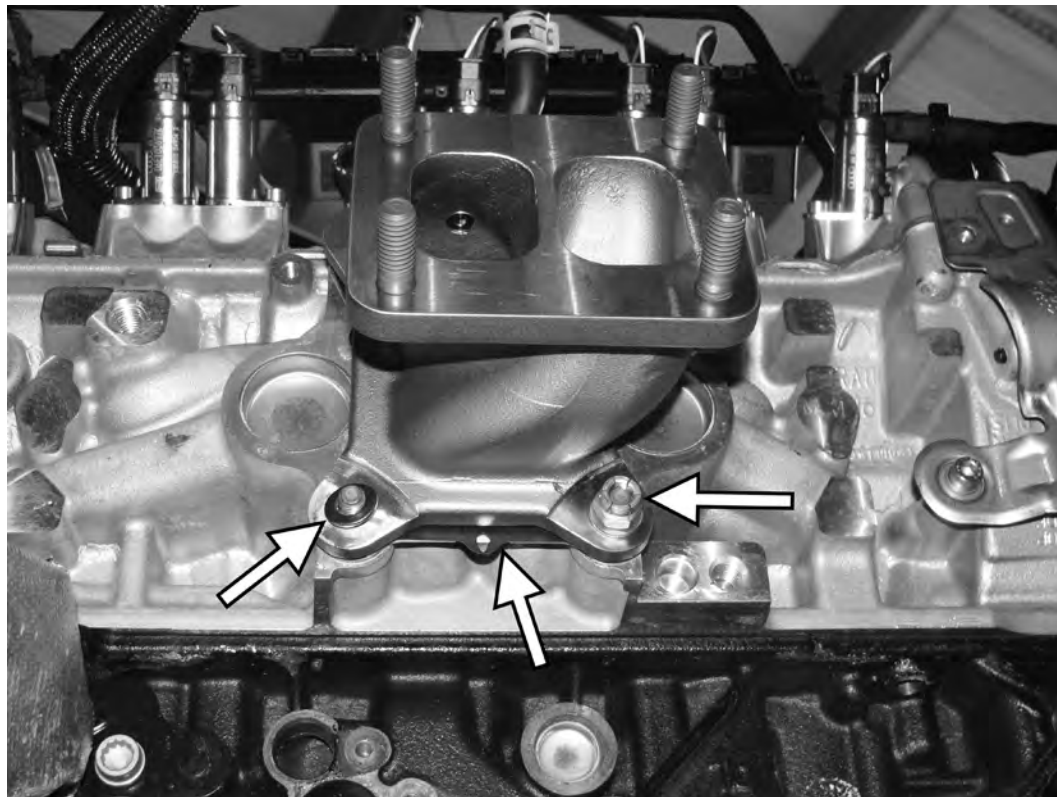

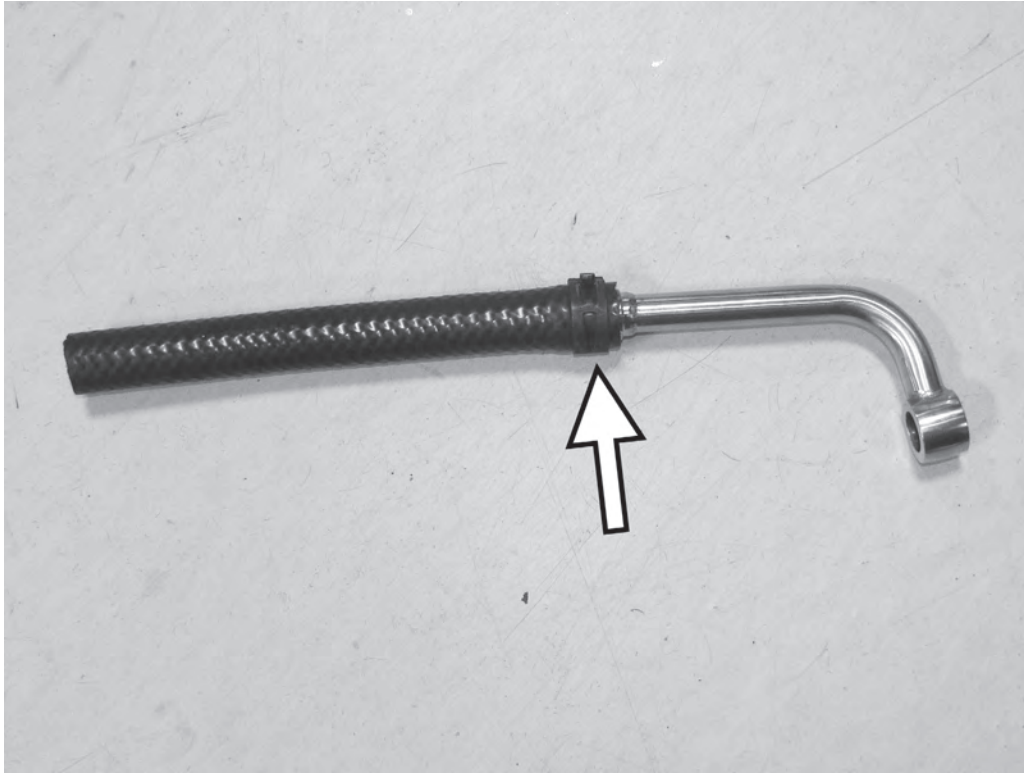

43) Assemble the APR coolant feed line with the supplied hose and a 23mm spring clamp.

44) Connect the APR coolant feed line to the turbocharger as shown. Use the supplied banjo bolt with two crush washers, one on both sides of the banjo fitting. Torque the banjo bolt to 40Nm (30lb-ft), orienting the final position of the line so it is almost touching the wastegate actuator bracket.

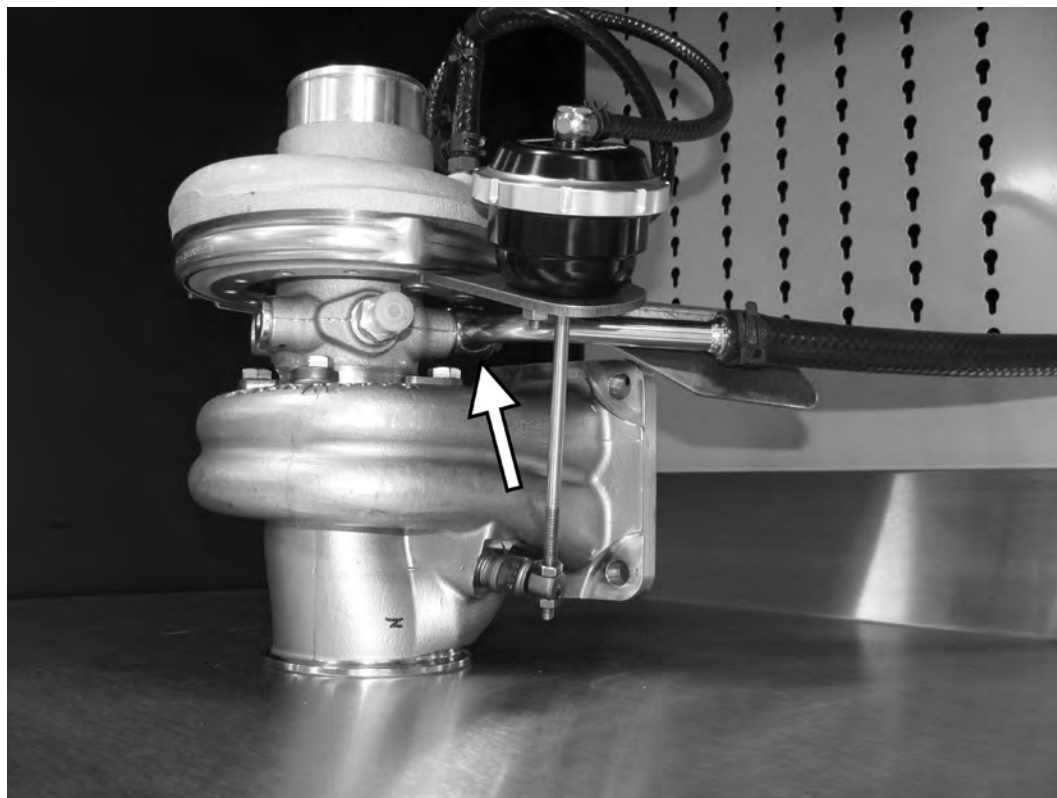

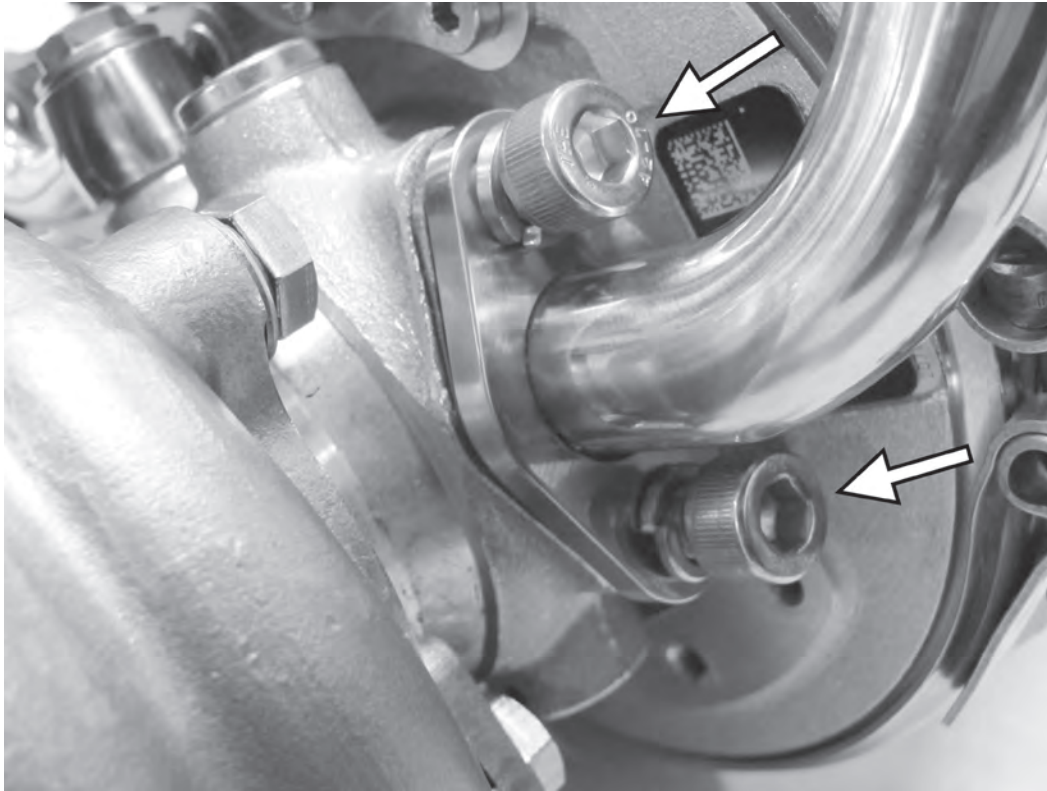

45) Install the supplied, red O-ring to the APR oil drain line after lubricating with engine oil. Loosely mount the oil drain line with the supplied gasket to the turbocharger with the two 6mm allen screws with lockwashers. Leave the screws only tightened by a couple of threads.

46) Install the supplied gasket on the APR adapter. Lift the turbocharger in place in the engine bay, making sure the coolant feed line goes between the valvelift solenoids of cylinders #2 and #3.



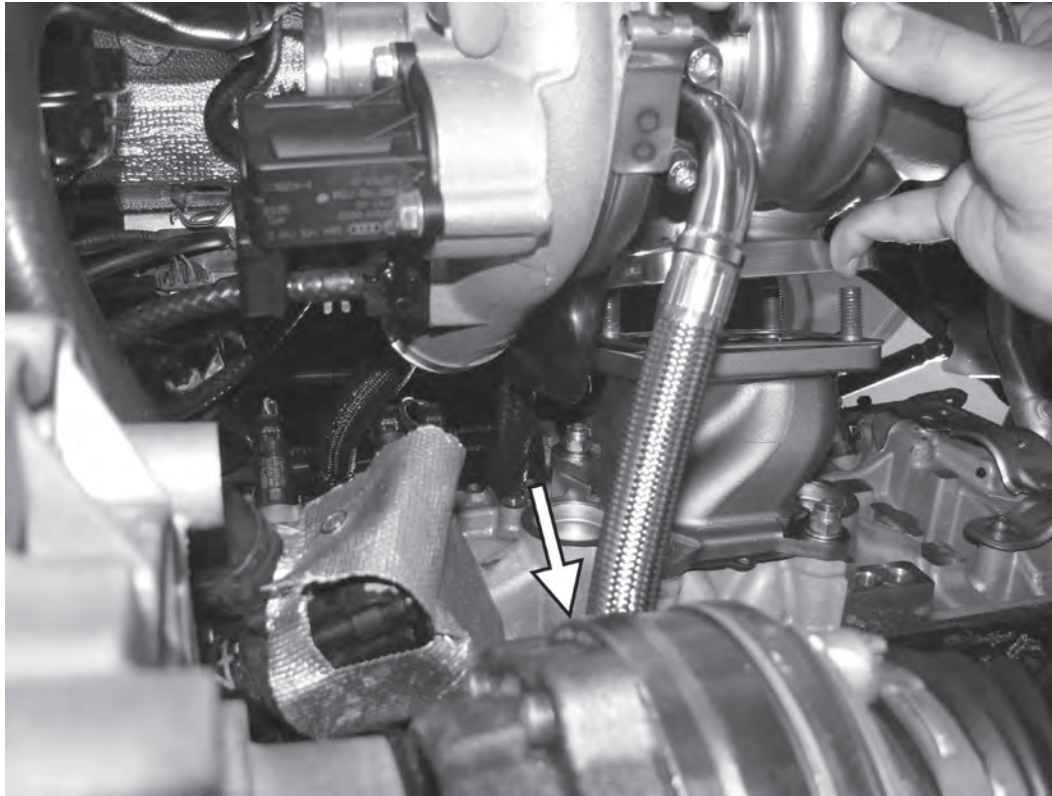

47) With the turbocharger about an inch away from mounting on the APR adapter, push the oil drain line into the correct hole in the engine block.

48) Slide the turbocharger on the studs of the APR adapter. As you put the turbo on, install the supplied 16mm copper locknut on the lower right stud. Tighten the 16mm nut with a wrench to seat the turbo to the face of the APR adapter.

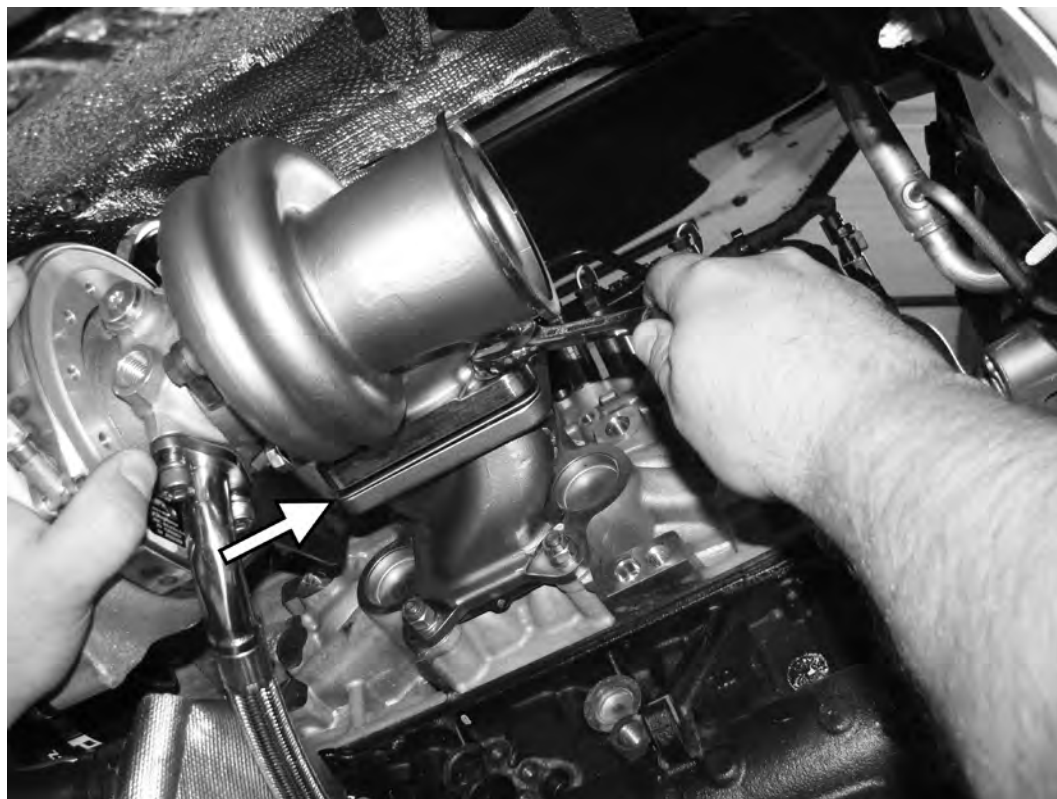

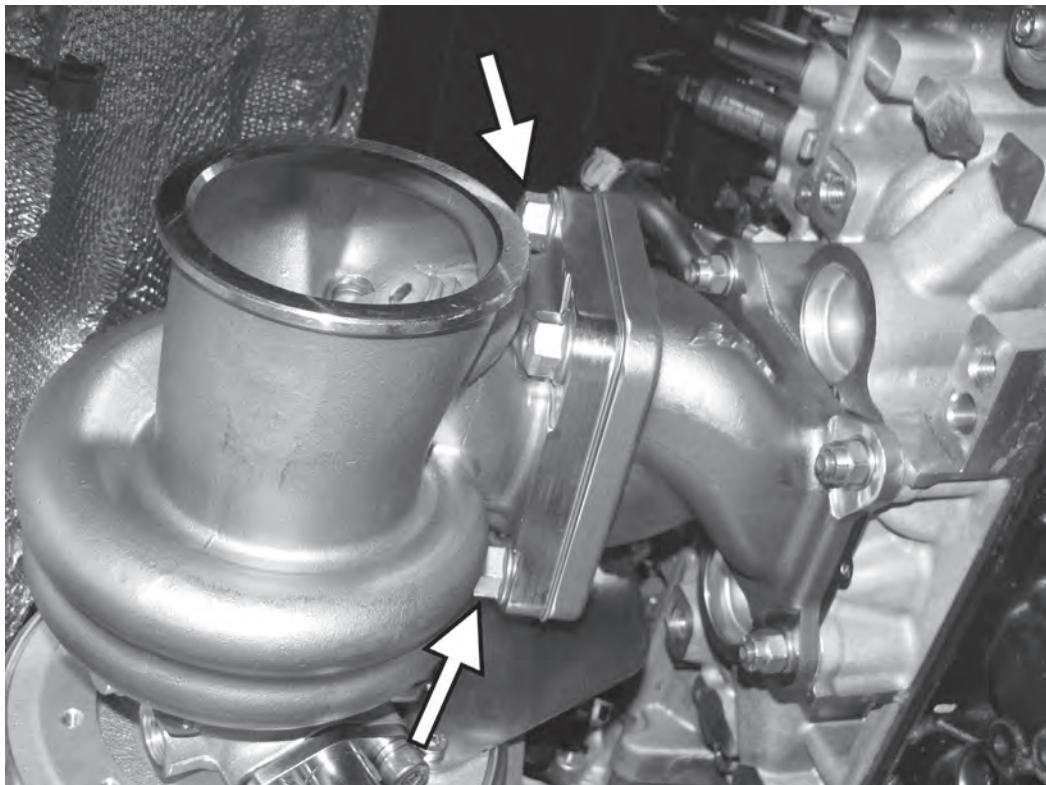

49) Install and tighten the three remaining 16mm locknuts holding the turbo to the APR adapter. Torque the locknuts to 40Nm (30lb-ft).

50) Install the 8mm triple square bolt holding the oil drain line to the engine block. Torque this bolt to 9Nm (80in-lb). Tighten the two 6mm allen screws holding the oil drain line, and torque these to 13.5Nm (120in-lb).

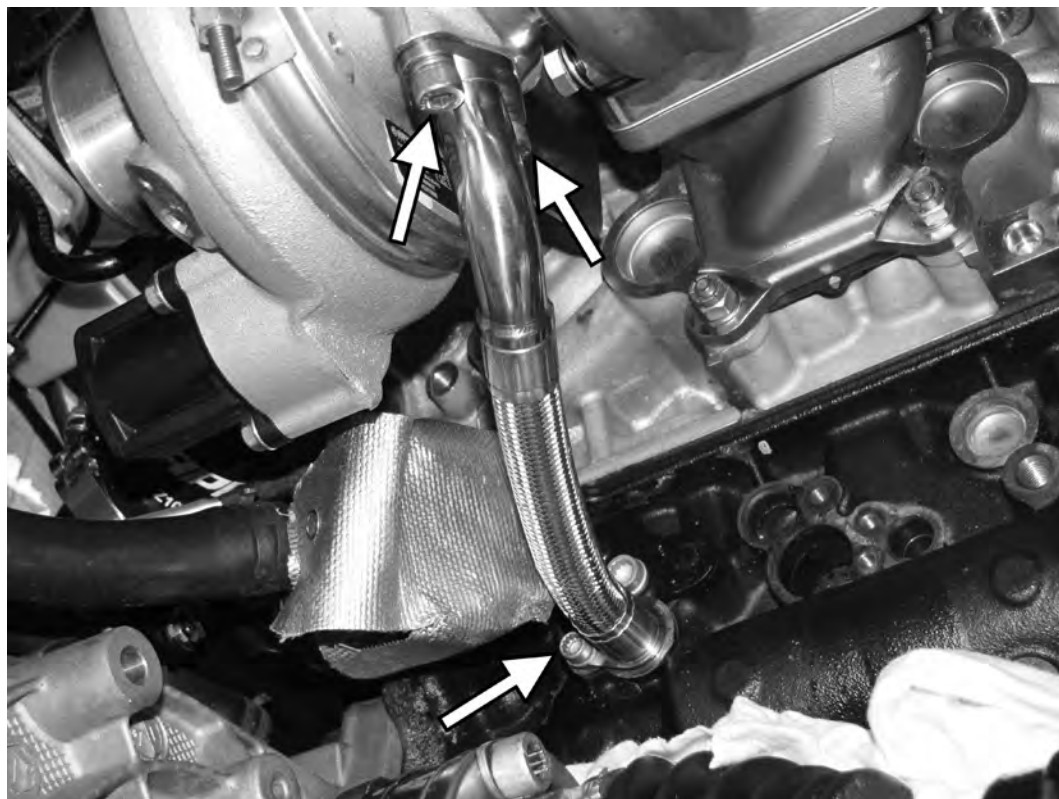

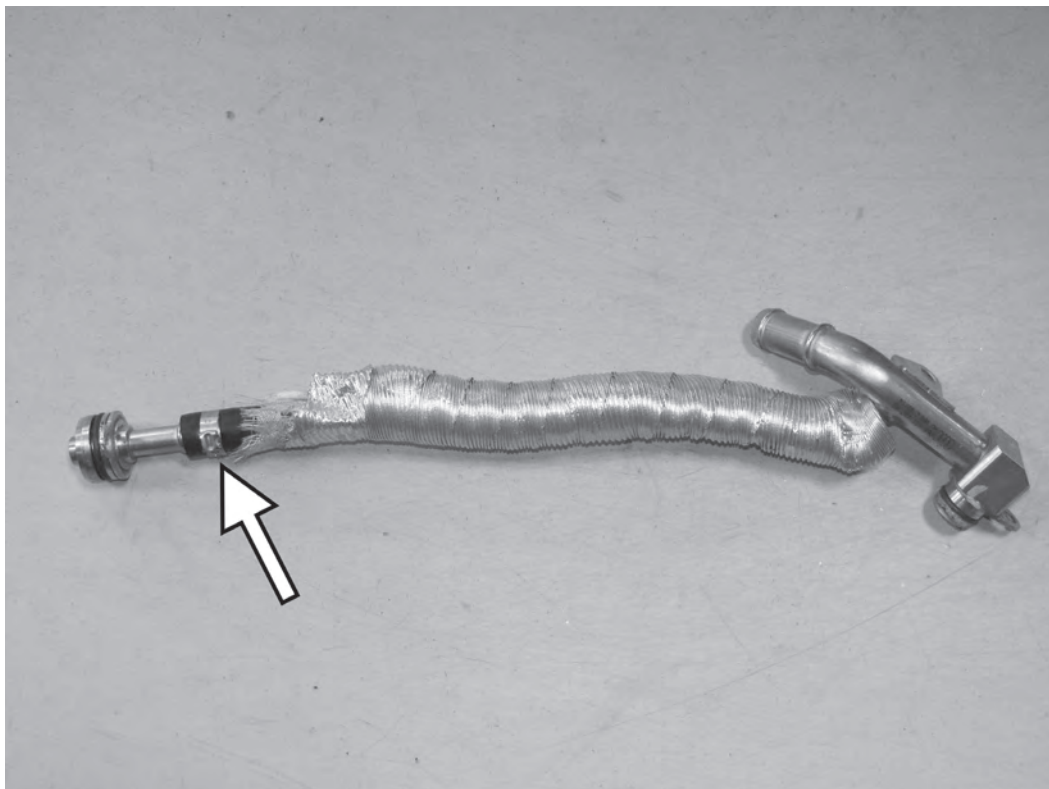

51) From the end of the stock coolant line, remove the outer sheathing near the lines connection to the engine block. Cut the ear clamp from the hose, and remove the end fitting that goes in the engine block from the factory rubber hose. This line does not have to be removed from the stock turbocharger.

52) Install the end fitting of the coolant line just removed into the engine block and secure with one of the 8mm triple square screws. Torque the screw to 9Nm (80in-lb).

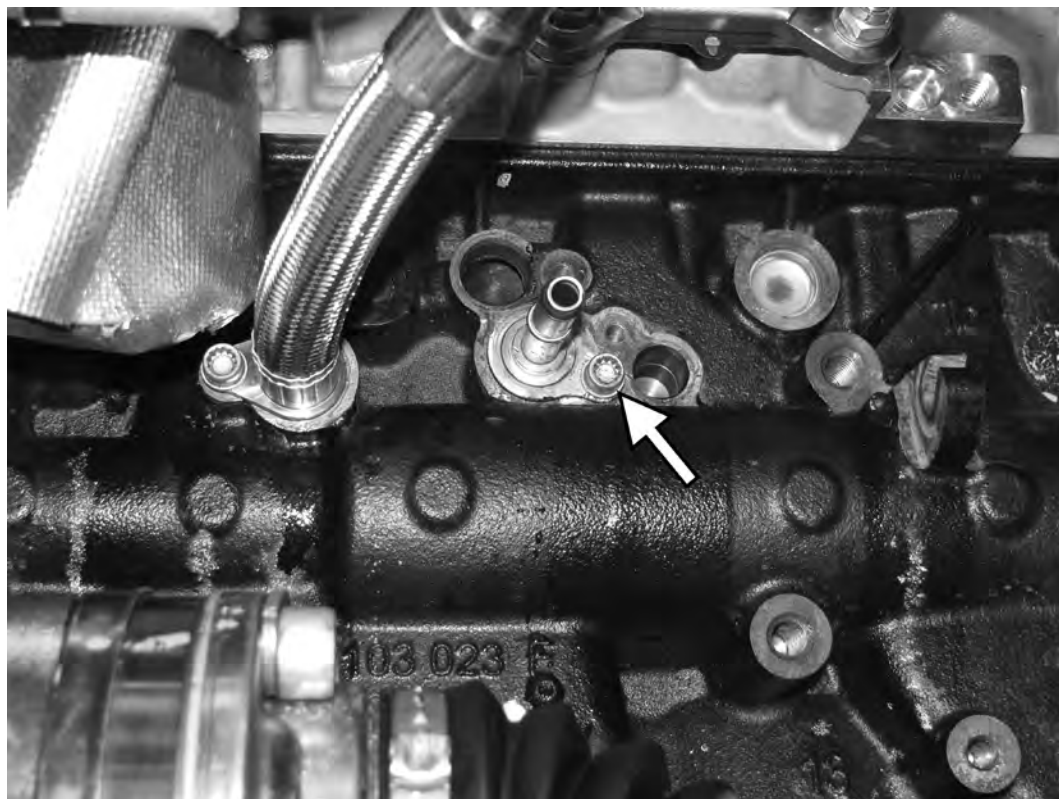

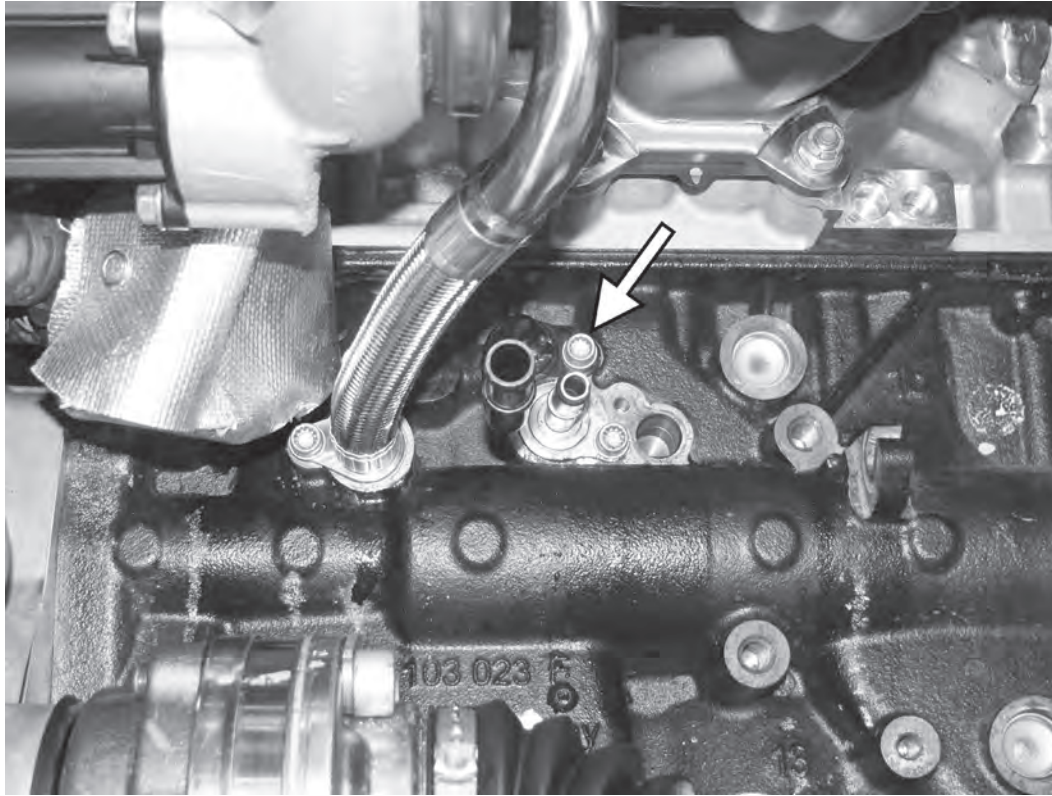

53) Install the black coolant line into the engine block and secure with another one of the 8mm triple square screws. Torque the screw to 9Nm (80in-lb).

54) Install the APR coolant return pipe on the turbo as shown. Install the 13mm banjo bolt with two crush washers, one on both sides of the banjo fitting. Make sure the APR coolant pipe is horizontal to the ground before tightening the banjo bolt. Torque the banjo bolt to 40Nm (30lb-ft).



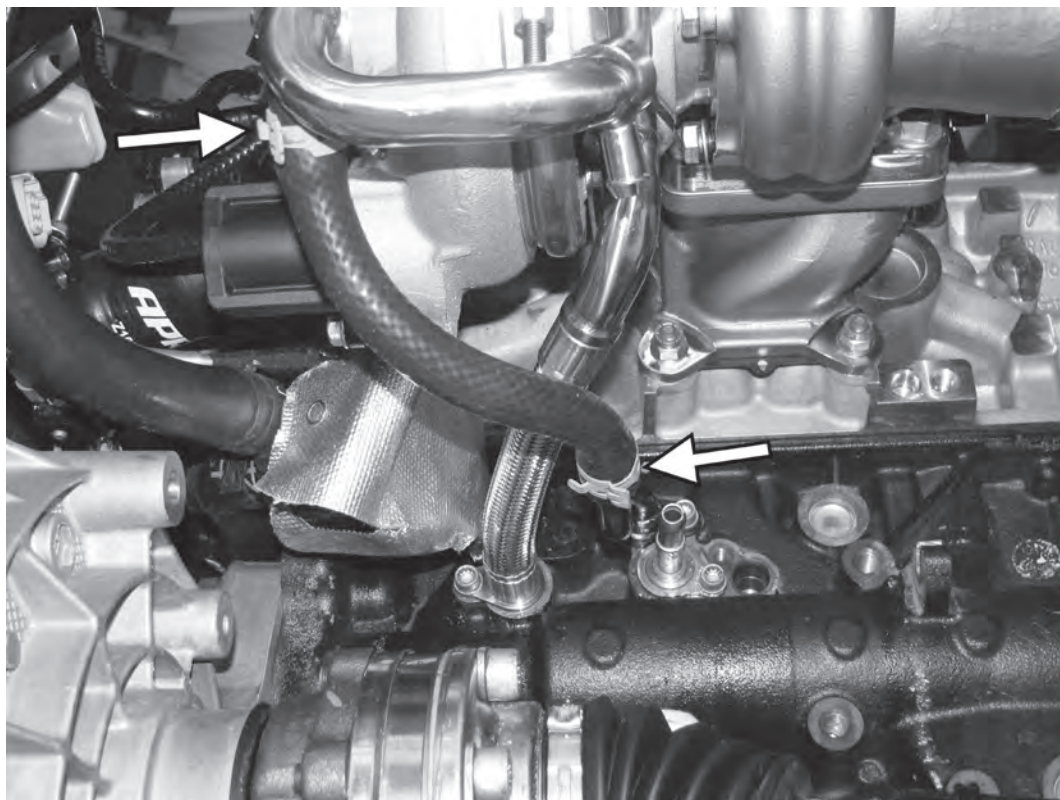

55) Install ~8.5" of the supplied coolant hose between the left port of the APR coolant pipe and the upper, black coolant pipe already installed in the engine block. Secure both ends with the supplied spring clamps.

56) Install ~9.5" of the supplied coolant hose between the right port of the APR coolant pipe and the lower coolant pipe already installed in the engine block. Secure the hose near the APR pipe with a spring clamp, and secure the end by the engine block with a crimp clamp.

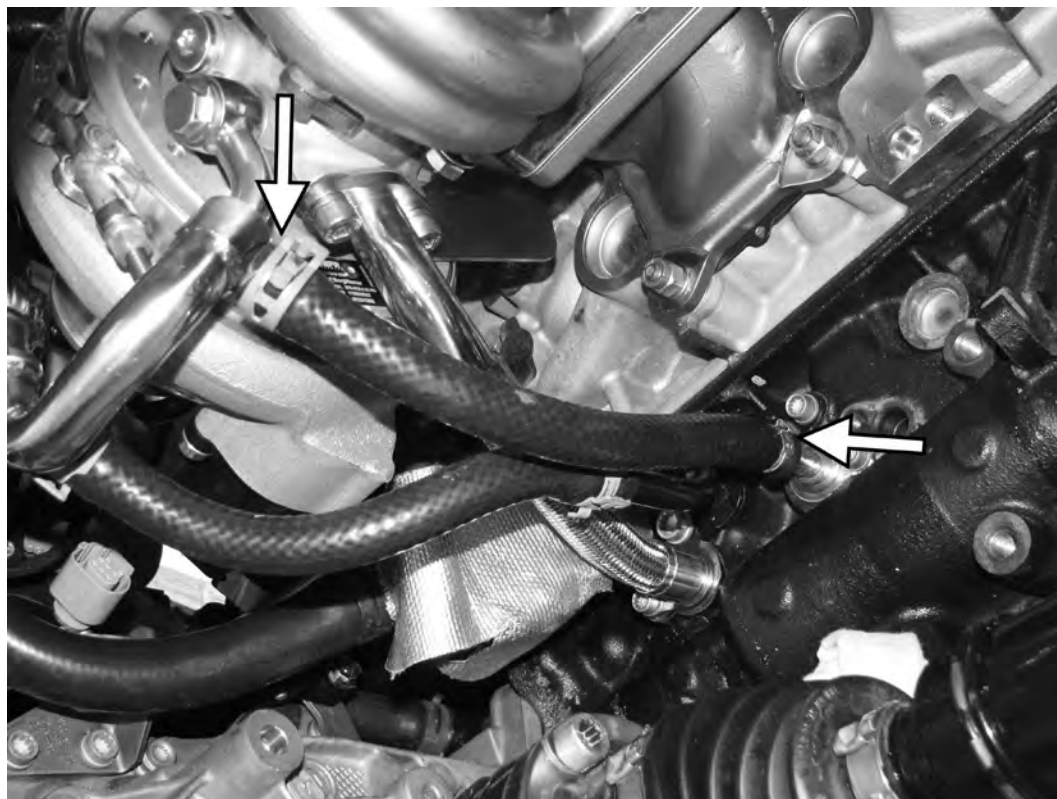

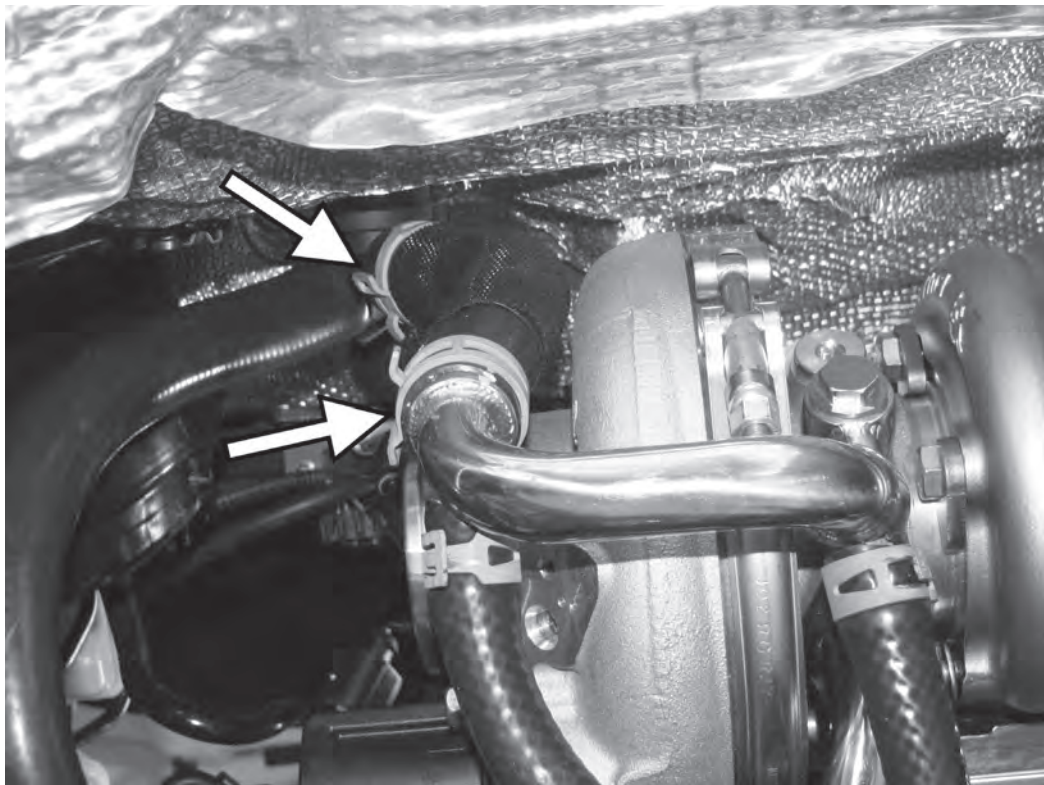

57) Test fit the molded 45° coolant hose between the APR coolant pipe and the heater hose connection. You should have to cut ~3/4" off one end of the supplied coolant hose. Test fit the hose to make sure it does not rest on the turbo compressor cover. Before installing, install the 4" of supplied abrasion sheathing on the coolant hose and heat with a heat gun to secure in place. Finally, install the molded coolant hose and secure with the two supplied spring clamps.

58) Install the supplied heat sheathing over the two coolant hoses that go from the APR coolant pipe to the back of the engine block.

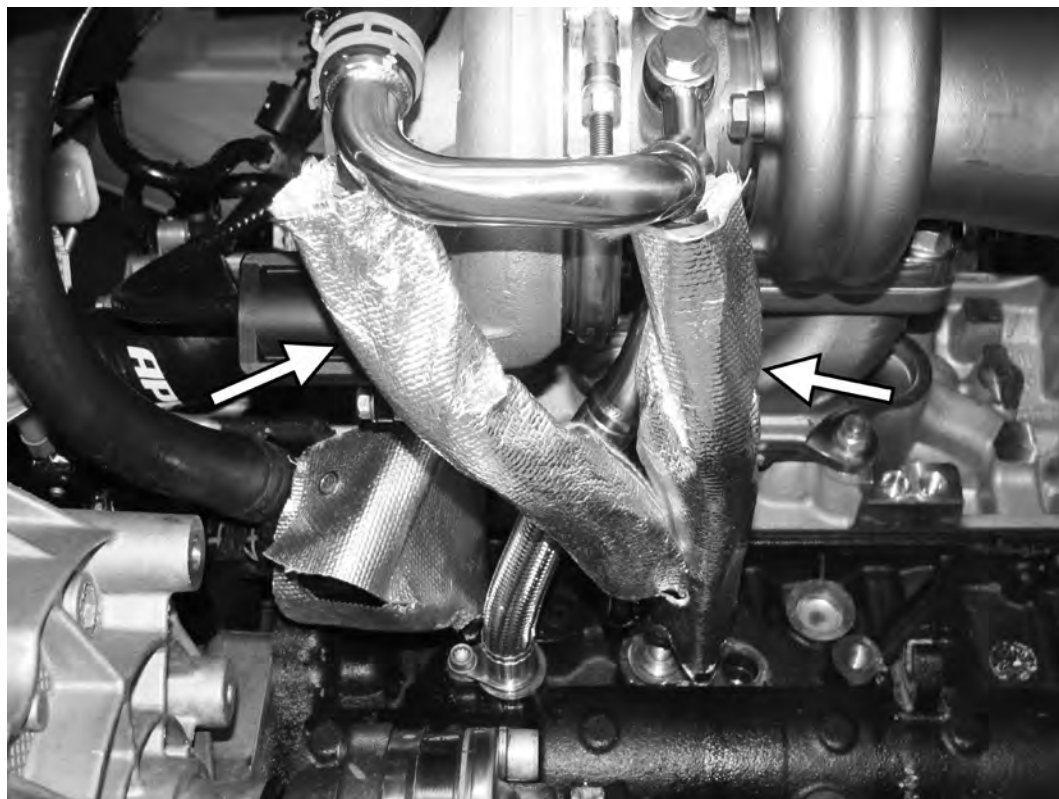

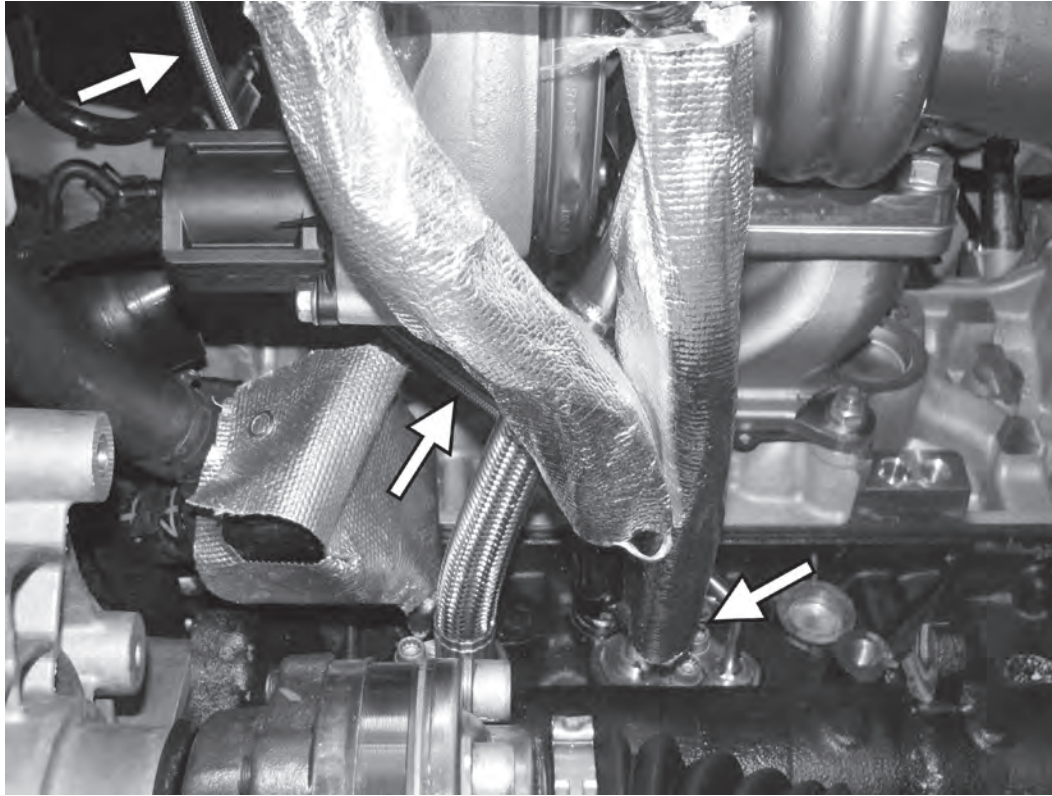

59) Install the oil feed line above the coolant lines and up the left side of the turbocharger. Connect the 8mm triple square bolt to secure the line in place, and torque the bolt to 9Nm (80in-lb).

60) Route the oil feed line up the left side of the turbo, under the wastegate actuator, and connect to the oil inlet on the top of the turbocharger. Tighten the oil feed line with a 14mm wrench, making sure the oil line does not touch the wastegate, wastegate actuator, wastegate bracket, or any of the vacuum lines.



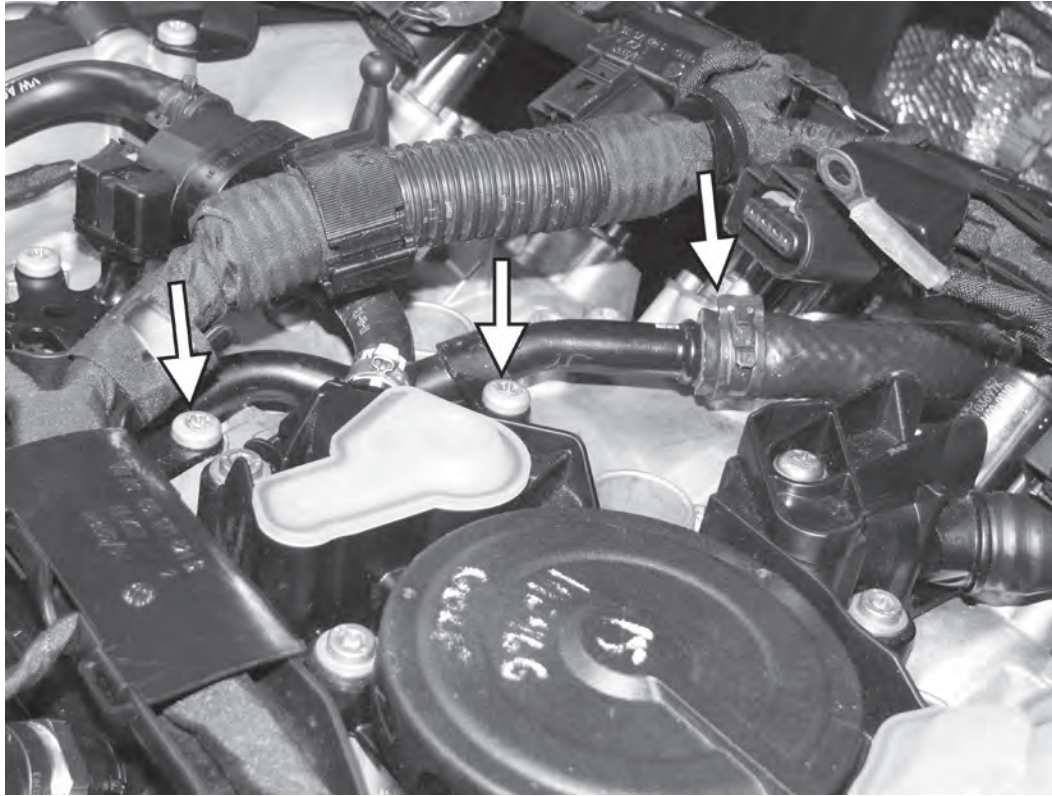

61) Loosely mount the stock coolant pipe to the top of the engine. Mark the APR coolant supply line, and trim the hose to length. Install the coolant feed hose to the stock coolant pipe and secure with the supplied hose clamp. Finally, install the two stock T30 screws holding the coolant pipe in place and torque to 9Nm (80in-lb).

62) Install the APR turbo support bracket. Tighten the bracket to the turbocharger with a 13mm wrench. Tighten to 13.5Nm (120in-lb). Install the stock 13mm bolt and supplied nut to hold the bracket to the engine block.

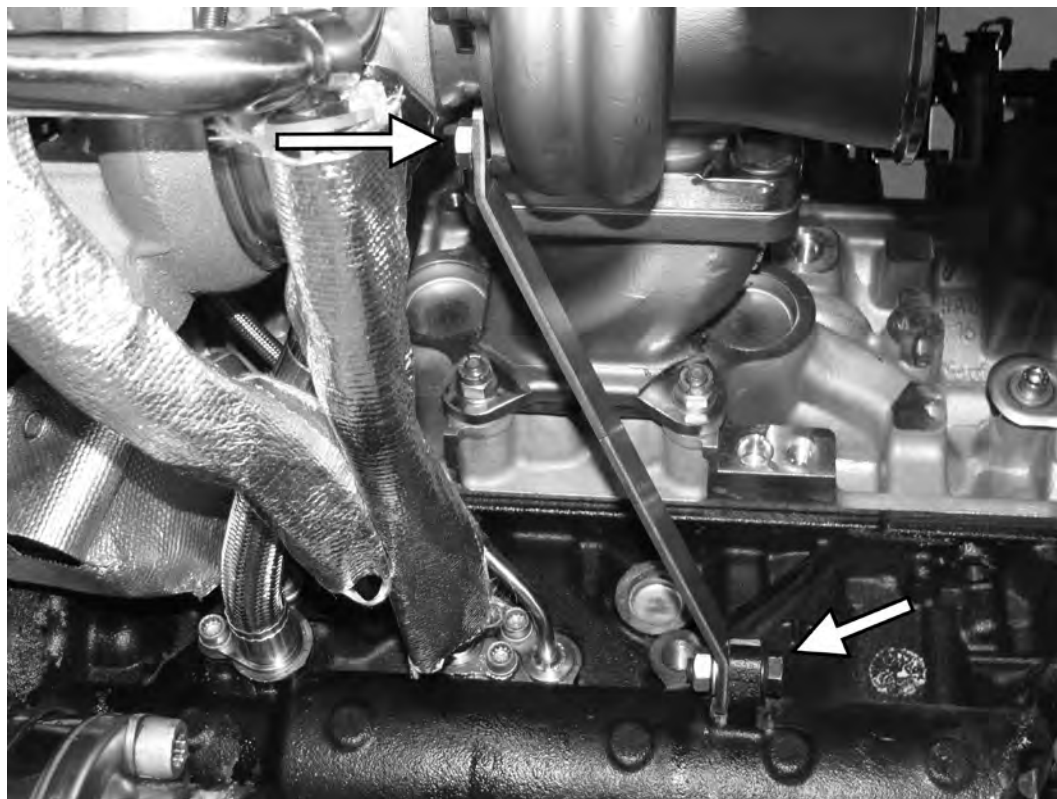

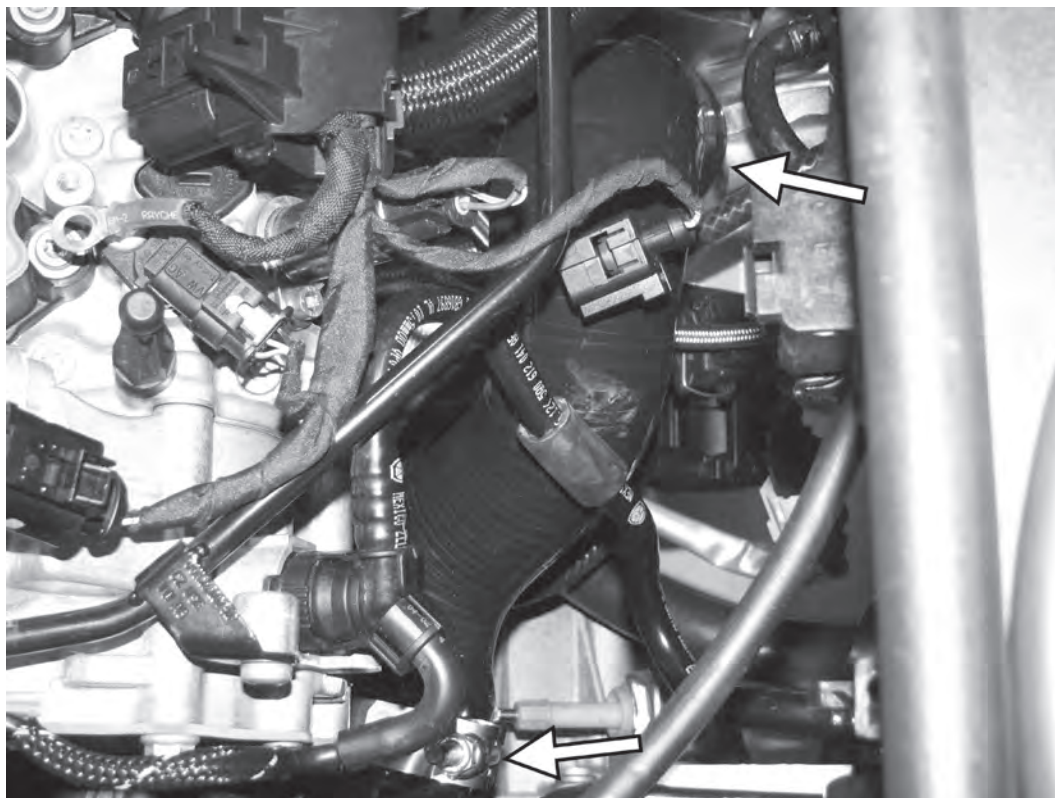

63) Install the APR turbo outlet hose between the compressor outlet and the stock turbo outlet pipe. Secure the end near the turbocharger with the supplied 2.12" (-0212) T-bolt clamp. Secure the end on the turbo outlet pipe with the supplied 2.5" (-0250) T-bolt clamp. Torque both clamps to 5.7-6.2Nm (50-55 in-lb).

64) Connect the short APR wastegate adapter harness (6 pin to 2 pin) between the factory 6 pin connector for the electronic wastegate and the two pin connector on the N75 valve mounted on the turbocharger. On AWD cars, you may have to remove the factory harness from the securing tab on the back side of the engine.

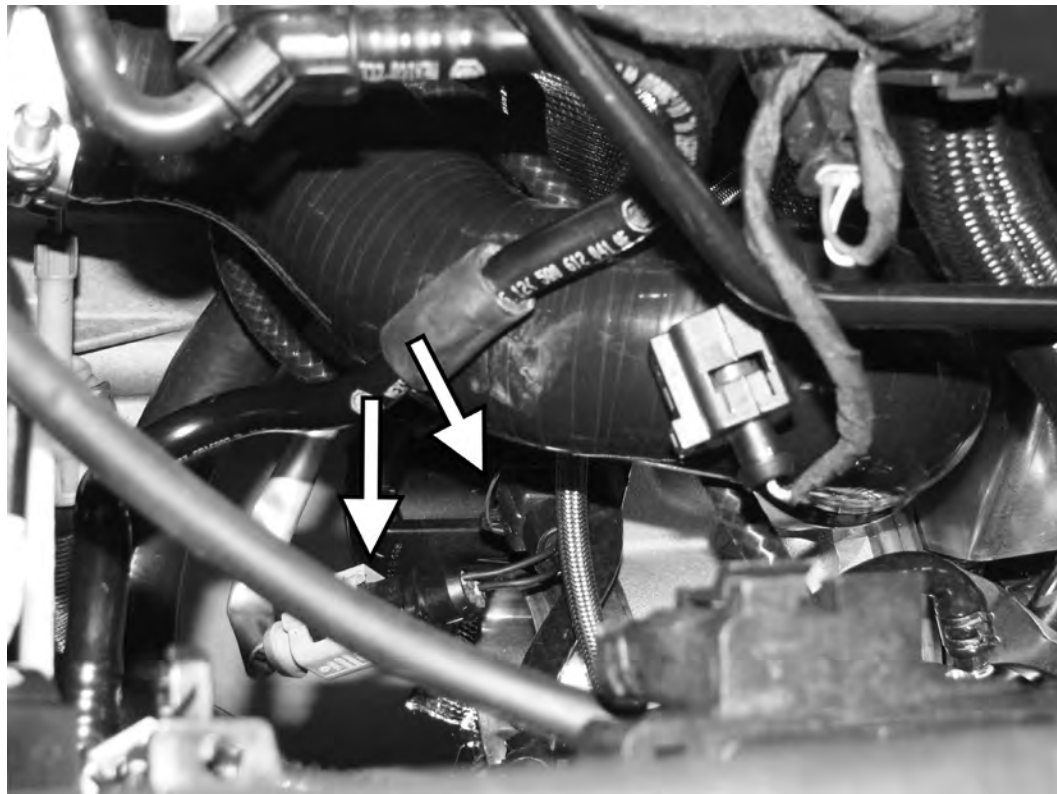

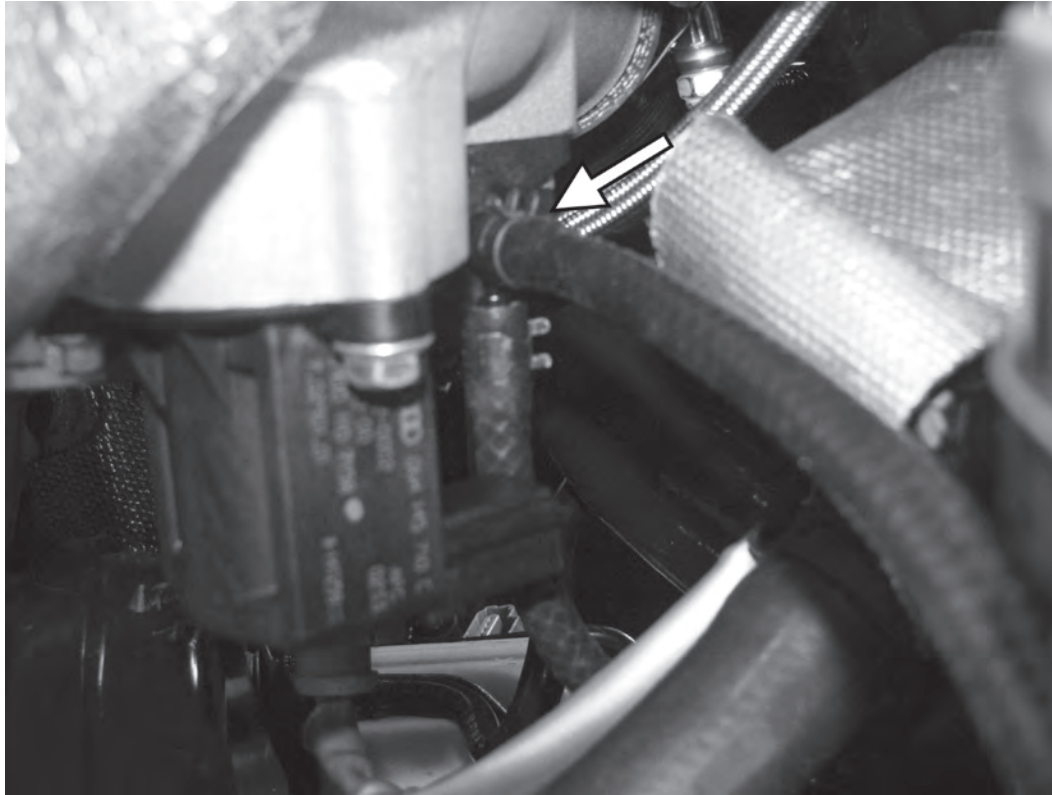

65) Install the small, reinforced vacuum line to the only open port of the N75 valve, on the bottom of the valve. Secure with the supplied spring hose clamp.

NOTE: On AWD cars, after the vacuum hose and clamp are installed, install the DV to the turbo compressor housing.

66) Route the vacuum line from the bottom port of the N75 valve up to the top of the engine bay. Install the APR turbo inlet hose to the turbocharger with the supplied screw clamp.



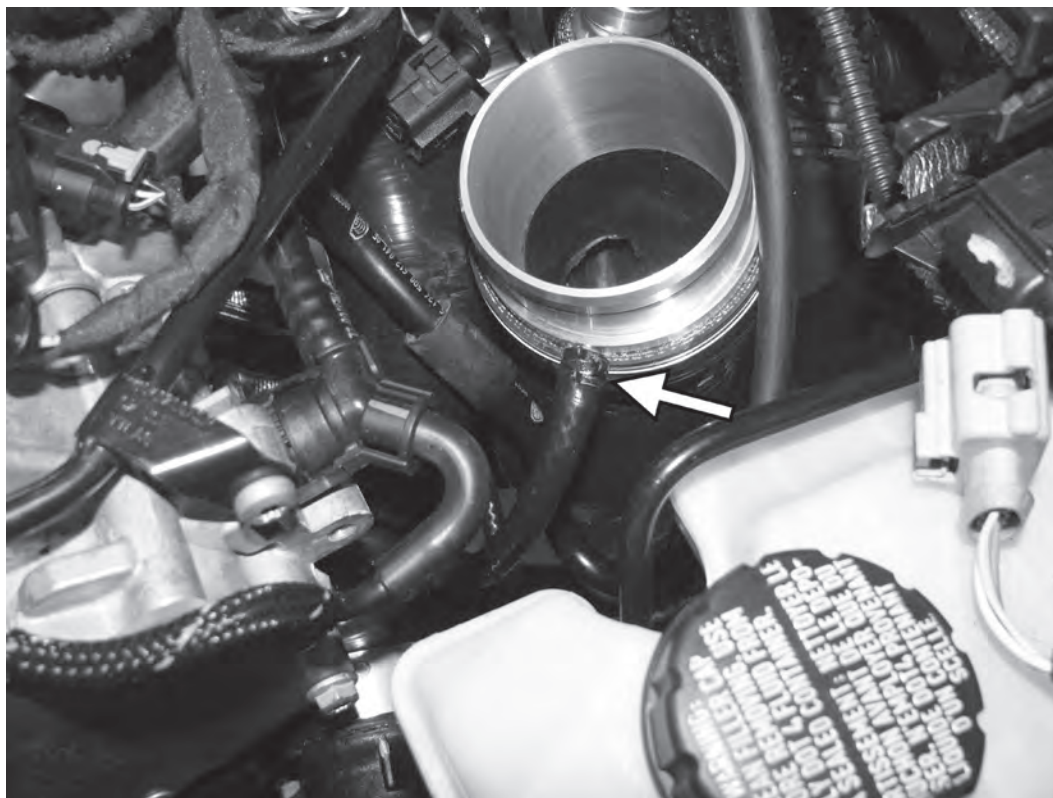

67) Connect the vacuum line from the bottom port of the N75 to the barbed fitting on the side of the APR turbo inlet hose, and secure with the supplied spring clamp.

68) Gap the supplied spark plugs to .024" +/- 0.002" (0.6mm +/- 0.05mm). Remove the stock spark plugs and replace with the gapped APR spark plugs. Torque the new plugs to 30Nm (22lb-ft) to crush the washer on the plug. Loosen all four plugs at least one full turn, and then re-torque the plugs to 22Nm (16lb-ft).



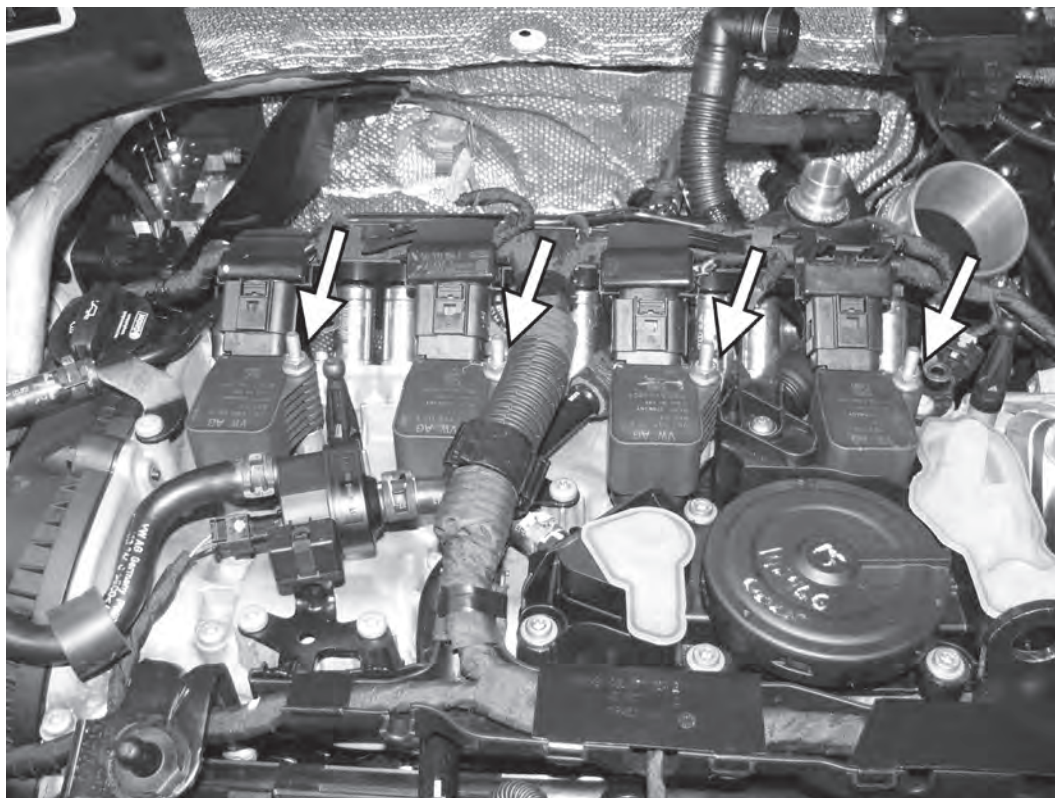

69) Reinstall the four coilpacks in the engine, loosely connecting the electrical connectors on the coilpacks. Install the four coilpack retaining bolts and torque to 10Nm (88in-lb).

70) Reinstall the four groundstraps to the coilpack retaining bolts, and secure with the four factory retaining nuts, torquing the nuts to 9Nm (80in-lb). Fully seat the four coilpack electrical connectors on the coilpacks, making sure each one clicks to lock in place.



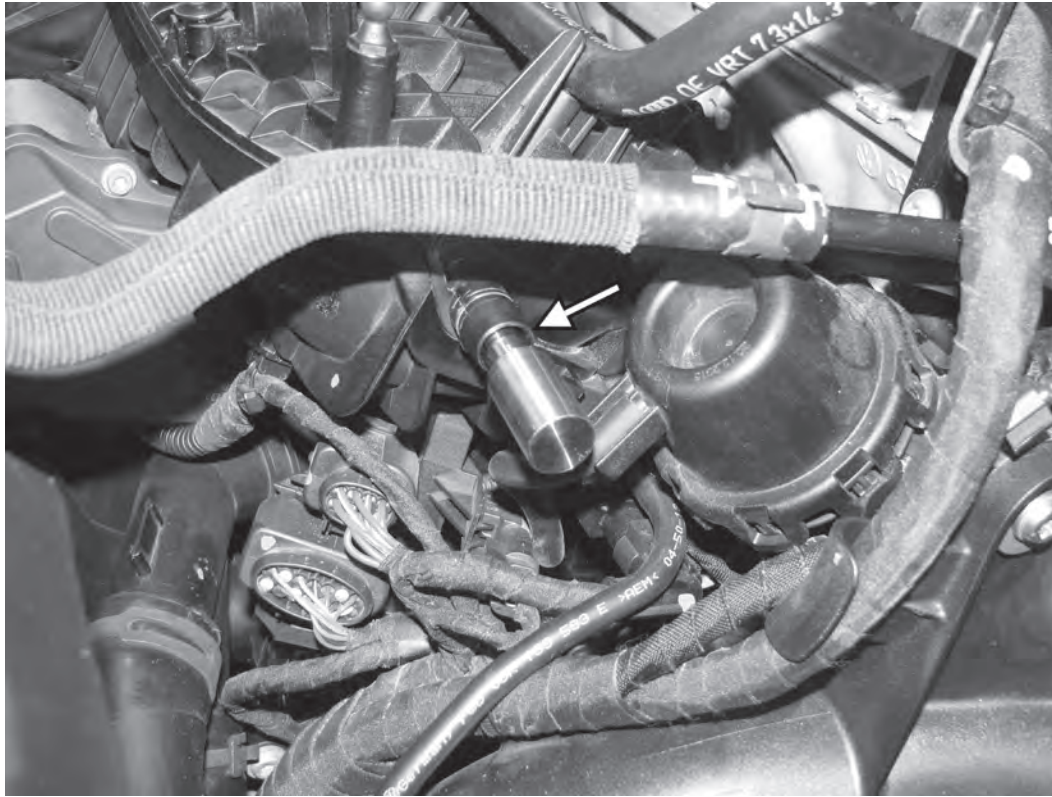

71) Locate the unused port on the front left side of the intake manifold. Place the APR punching tool loosely into this port.

72) Gently tap on the APR punching tool with a hammer into the intake manifold until the tool stops at the end of the intake port.

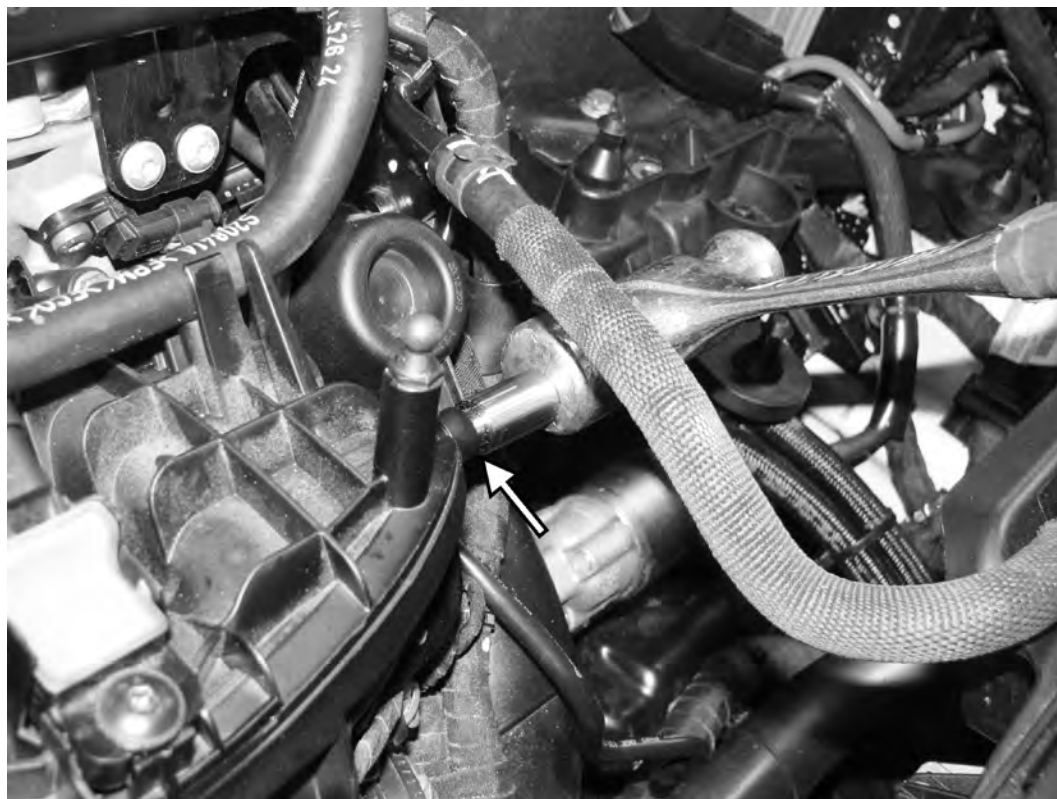



73) Unscrew the two portions of the APR boost tap. Carefully mount the main body of the boost tap in a bench vice with rags to protect the finish, being careful not to bend or crush the barbed fitting. Apply the supplied thread sealant to the threads of the APR boost sensor, and then install in the APR boost tap. Tighten the sensor with an adjustable wrench.

74) Apply a very small amount of the supplied anti-sieze to the threaded portion of the main body of the APR boost tap. If not installing a boost gauge, install the supplied cap on the APR boost tap.



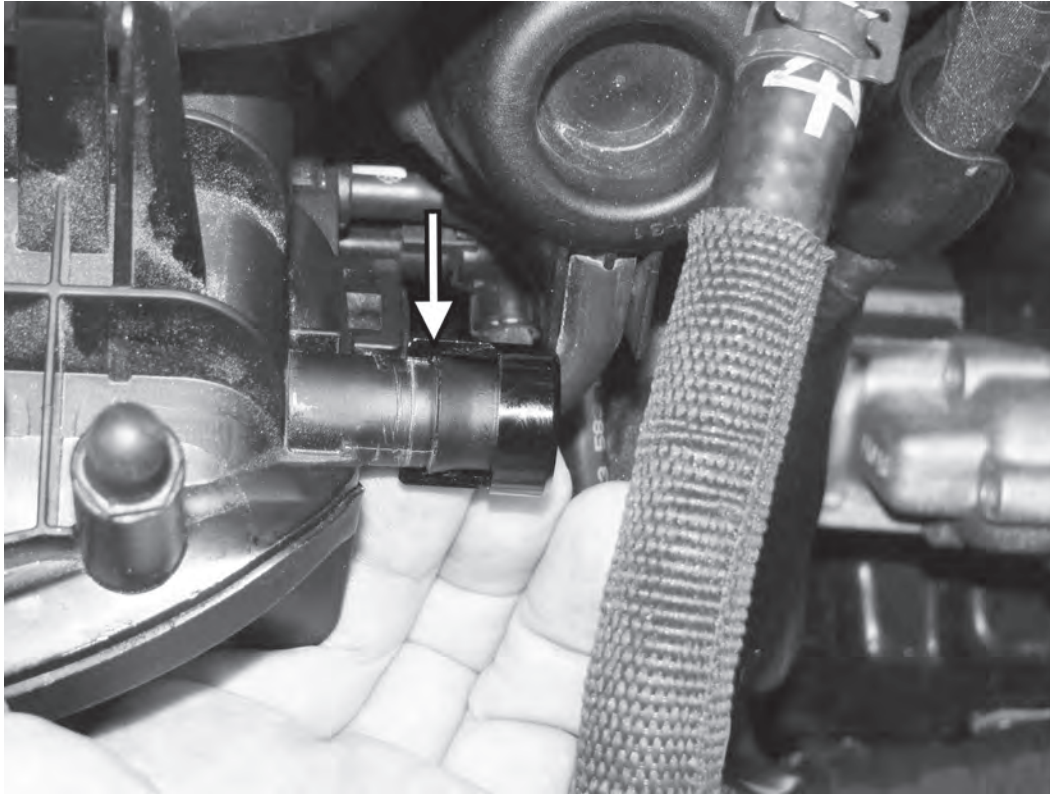

75) Loosely place the base of the APR boost tap on the port on the intake manifold. Make sure the lip of the boost tap base grabs the grooved lip on the intake manifold port.

76) Begin to thread the main body of the APR boost tap into the base of the boost tap. Turn the base of the boost tap clockwise to tighten the boost tap body to the intake manifold. The boost tap can be oriented to whatever desired position you want by manipulating the base to the main body, but be aware that it only should be hand tightened and with the boost sensor pointing down. If installing a boost gauge, connect a vacuum line to the barbed port on the boost tap.



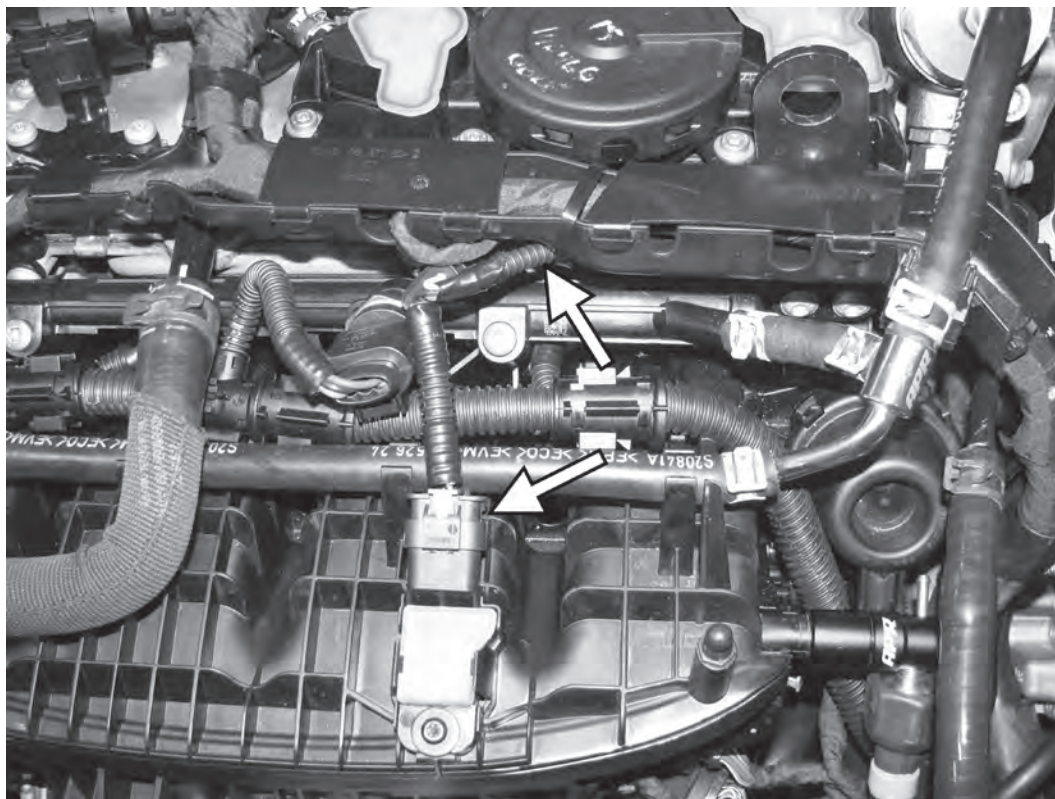

77) Unplug the electrical connector to the TMAP sensor on top of the intake manifold. Install the APR boost sensor harness to the mating connectors on the TMAP and the factory wiring harness.

78) Route the other end of the APR boost sensor harness underneath the factory wiring harness above the intake manifold towards the left side of the car. Route the harness behind the turbo outlet pipe and to the APR boost sensor. Connect to the APR boost sensor and secure the harness with the supplied cable ties. Tighten the T30 screw to secure the turbo inlet pipe.

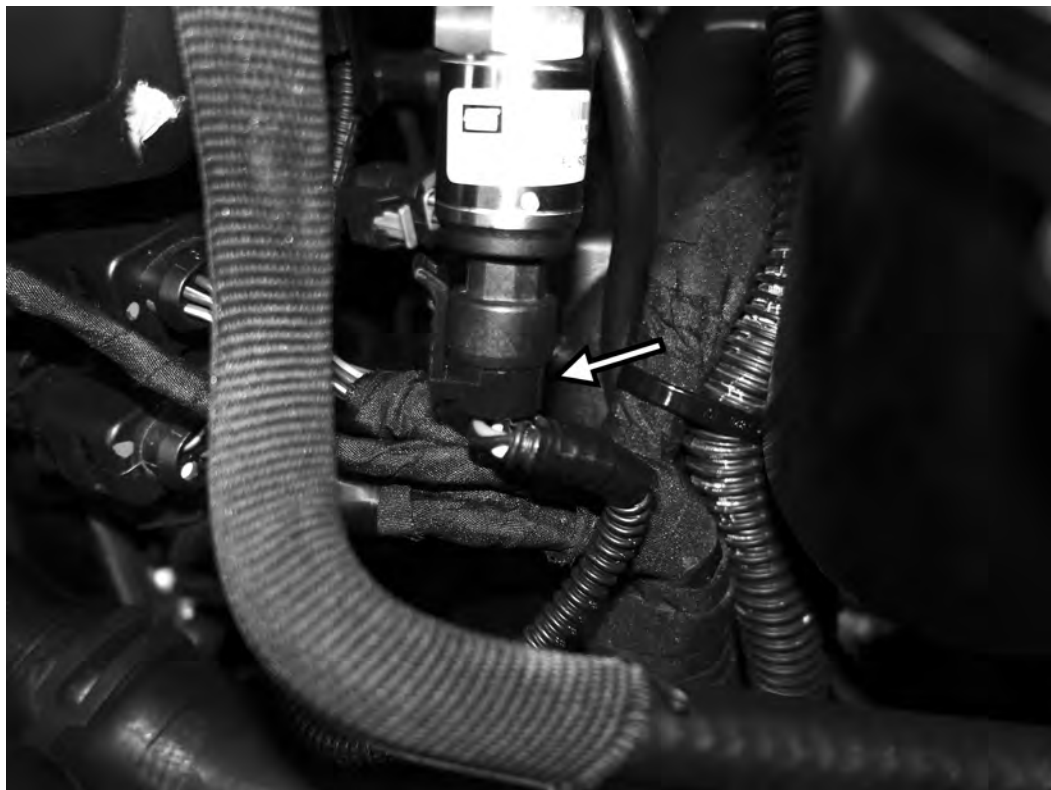

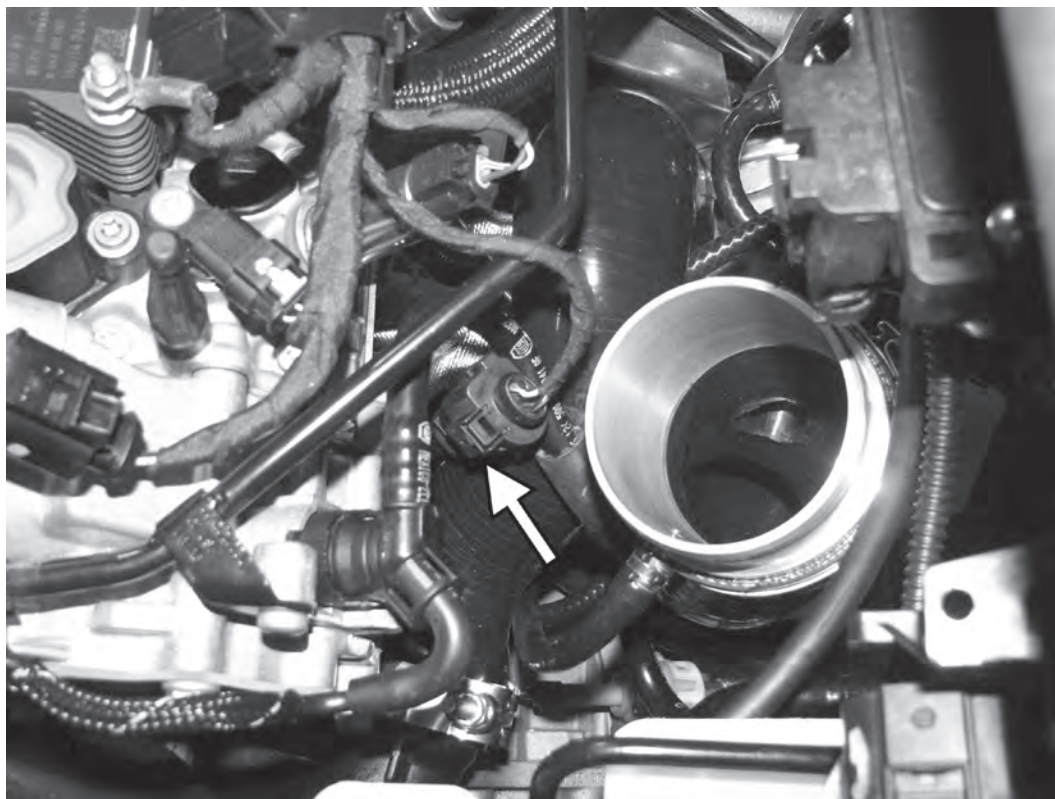

79) Connect the APR diverter valve extension harness to the mating connector on the factory wiring harness. Route the harness down, and connect the other end to the factory diverter valve from underneath the car.

80) With the subframe assembly on a transmission jack, bring the subframe back close to its mounting position in the car. When close enough, connect the six ball joint studs into both of the lower control arms. Loosely secure with the 16mm nuts.

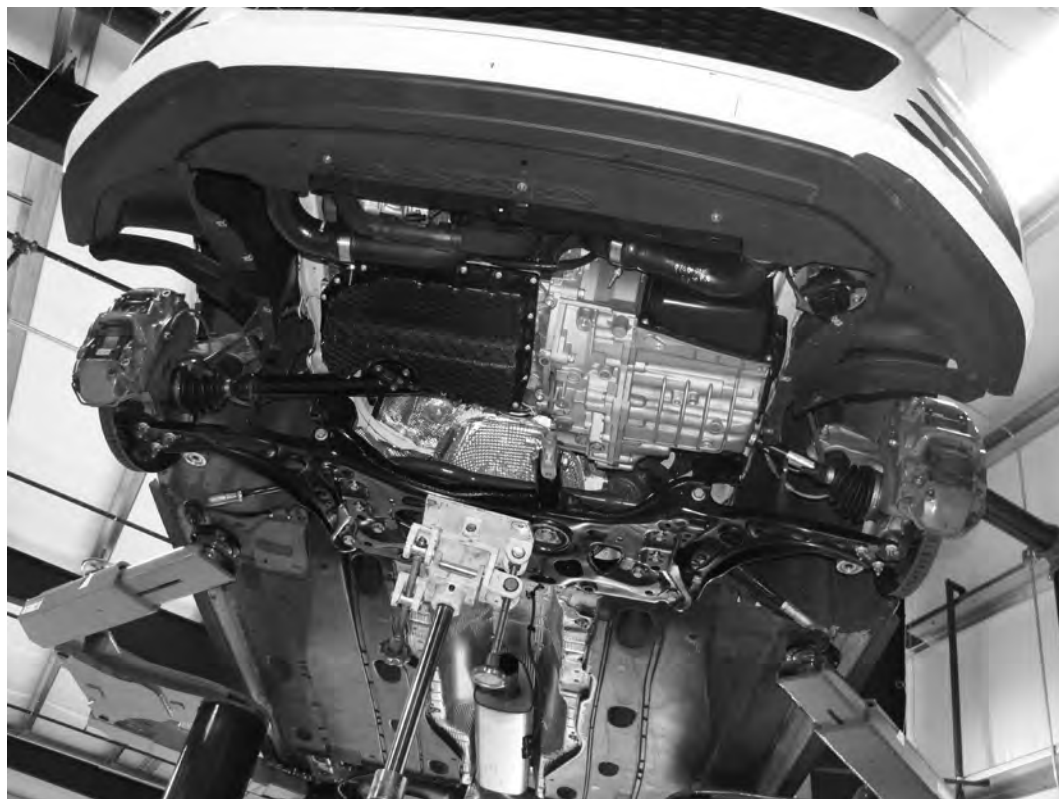

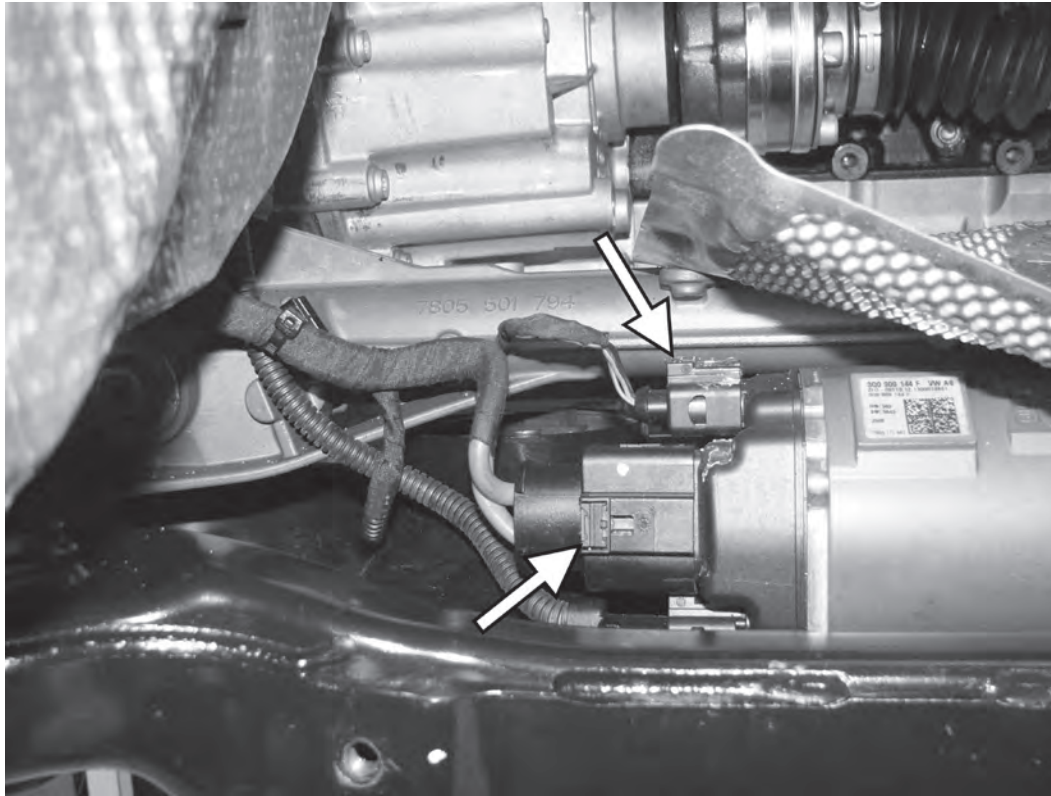

81) Reconnect the two electrical connectors to the top two plugs on the steering rack. Route the oil level sensor harness back to the front of the subframe, between the steering rack and the subframe. Reconnect the two wiring harness retaining clips to the subframe.

82) Carefully raise the subframe into its factory mounting location, making sure the top of the steering rack is aligned with the hole in the fire-wall for the steering shaft. Loosely install the two 18mm bolts accessed through the holes in the lower control arms. Loosely install the two rear 18mm bolts with the rear subframe brackets. Finally, loosely install the four 13mm bolts holding the back of the rear subframe brackets in place. You can now remove the transmission jack from the subframe.

NOTE: As all of the subframe nuts and bolts are torque to yield, they should be replaced every time they are used. The torque specs given are a reference only, please refer to the factory service manual for the particular car you are working on for any variations.



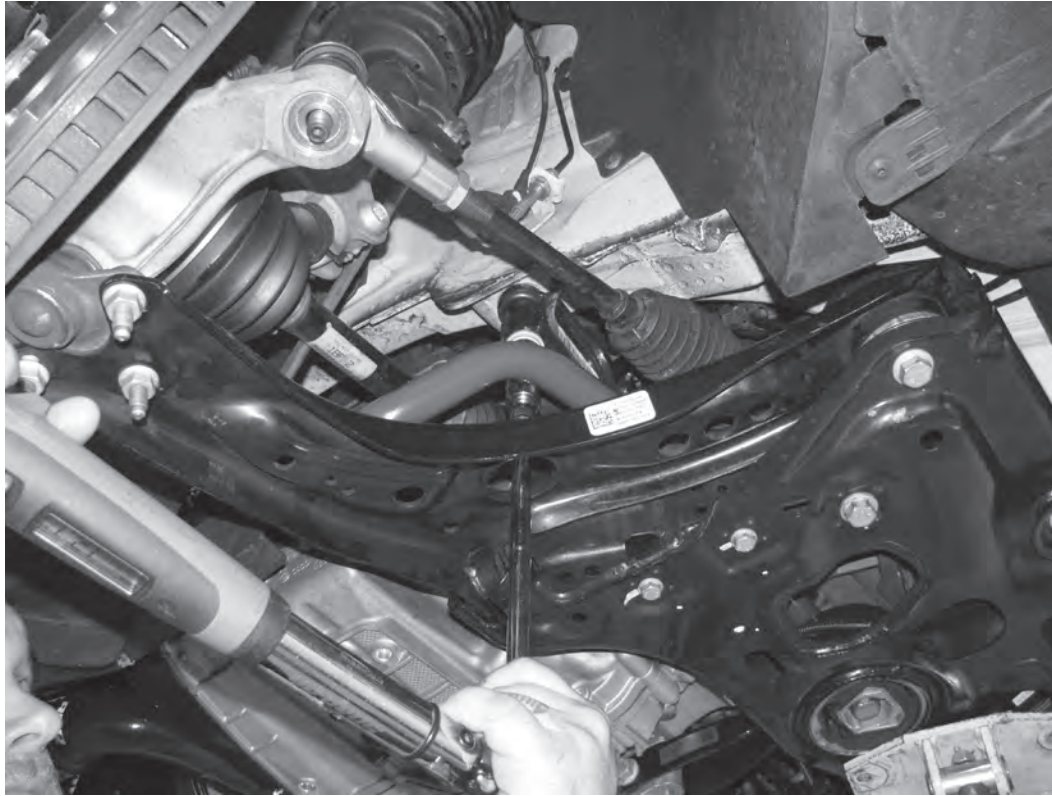

83) As you tighten the four main 18mm bolts holding the subframe in place, try to get the subframe as close as possible to its original mounting location as possible. Tighten the four 18mm bolts to 70Nm (52lb-ft), and then tighten them an additional 180°. Tighten the four 13mm bolts on the back of the rear subframe brackets to 50Nm (37lb-ft), and then tighten an additional 90°.

84) Tighten the six 16mm ball joint nuts and torque to 40Nm (30lb-ft), then tighten an additional 45°. Install the tie rod ends to the uprights and secure with the two 21mm nuts. Tighten these two nuts to 20Nm (15lb-ft), and then tighten an additional 90°.



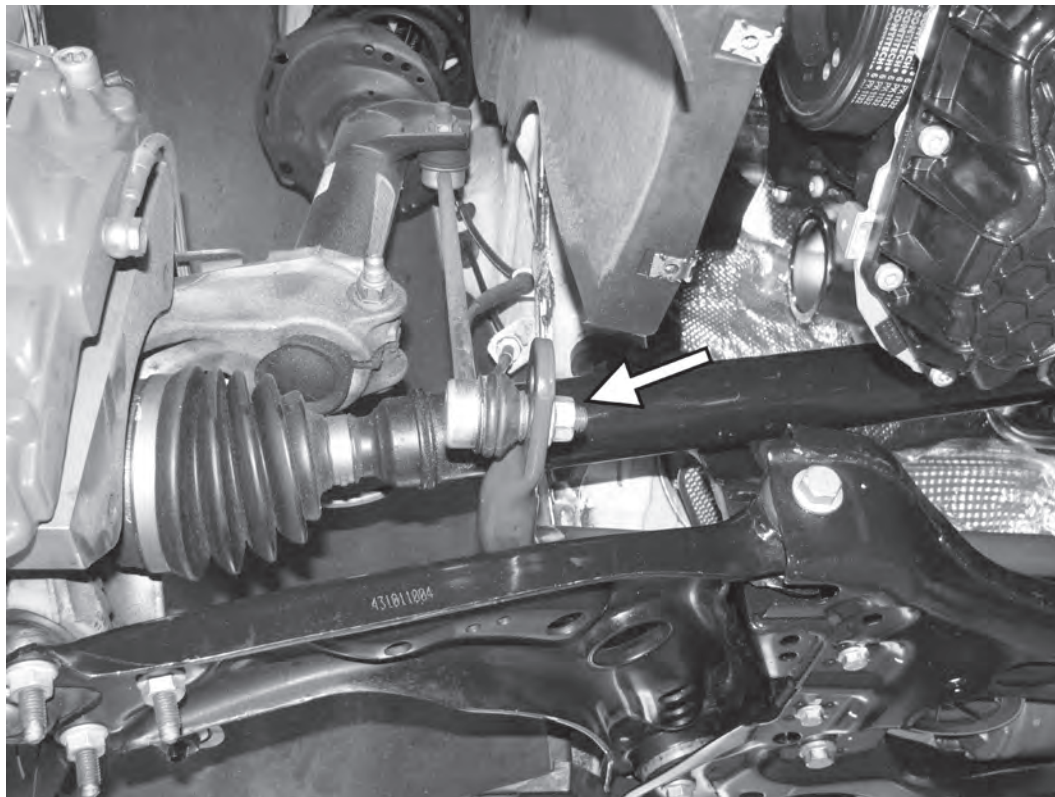

85) Install the sway bar into the sway bar endlink, and install the two 18mm nuts holding the sway bar in place. Torque the nuts to 65Nm (48lb-ft). It may be necessary to counterhold the shaft of the joint with a 6mm triple square.

86) Reconnect the wiring harness to the oil level sensor. Secure the two factory mounting clips to the side of the transmission.

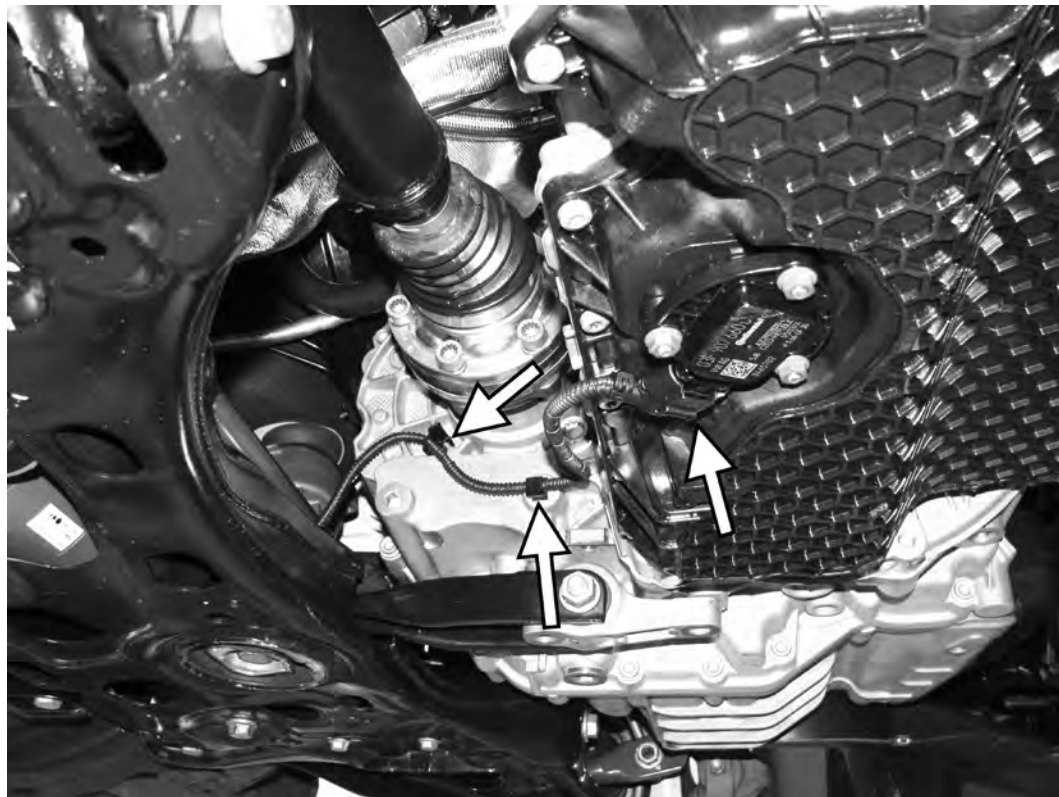

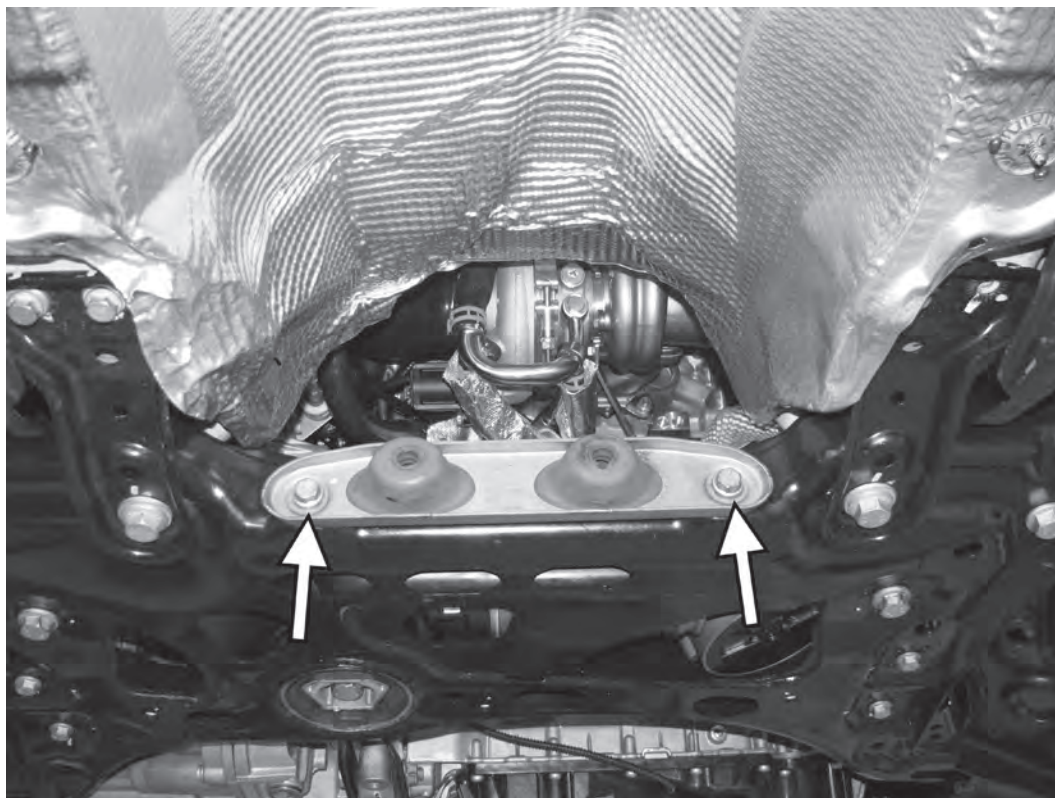

87) Remove the factory mount from the downpipe, and install it on the subframe with the two 13mm factory bolts.

88) Pulling the bottom of the engine back towards the back of the car, reinstall the two 16mm bolts holding the front of the lower engine mount to the transmission. Torque the bolts to 50Nm (37lb-ft), and then tighten an additional 90°.

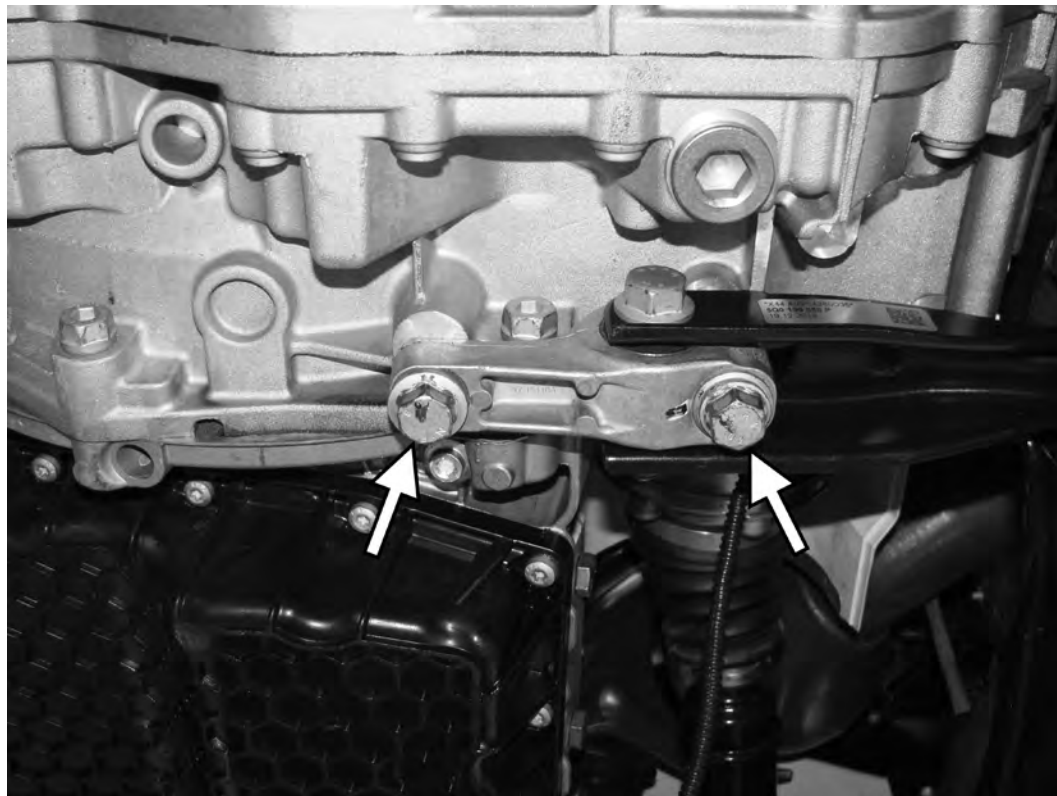

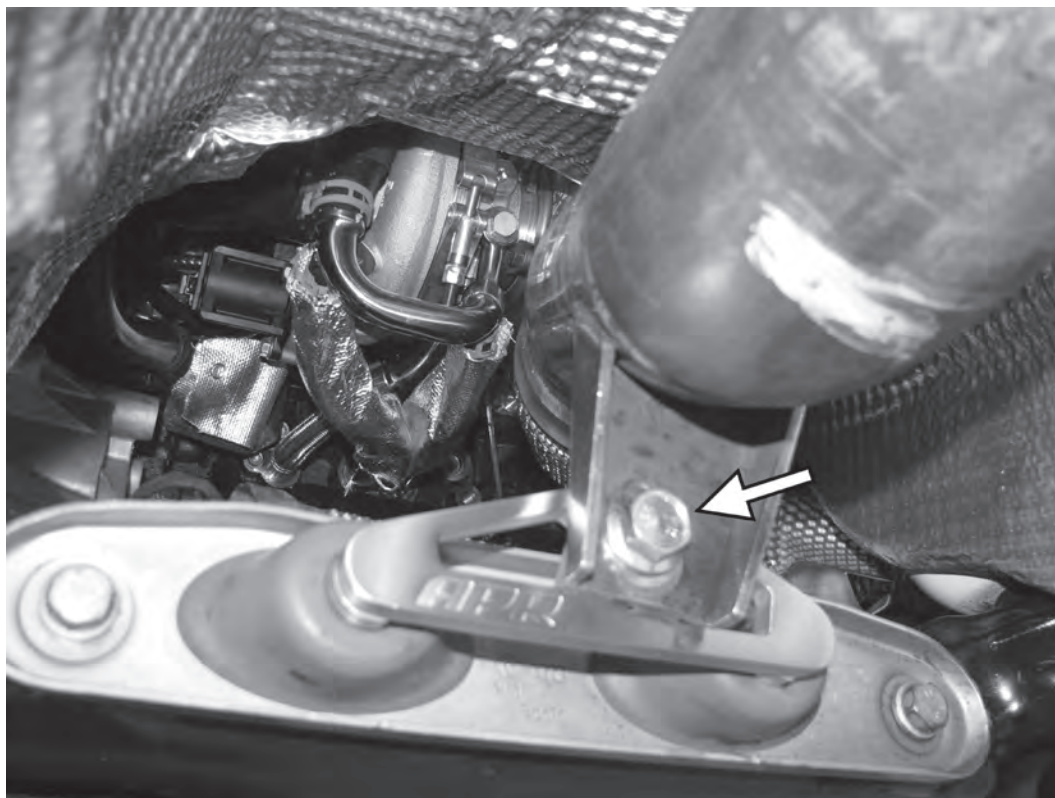

89) Loosely place the APR downpipe in the car. Attach the APR downpipe hanger to the bracket on the back of the subframe, and then loosely install the supplied nut and bolt to hold the downpipe to the bracket.

90) Loosely install the included V-band clamp between the turbo and downpipe. Leave the clamp loose so the downpipe will not fall, but can be rotated for final fitment.



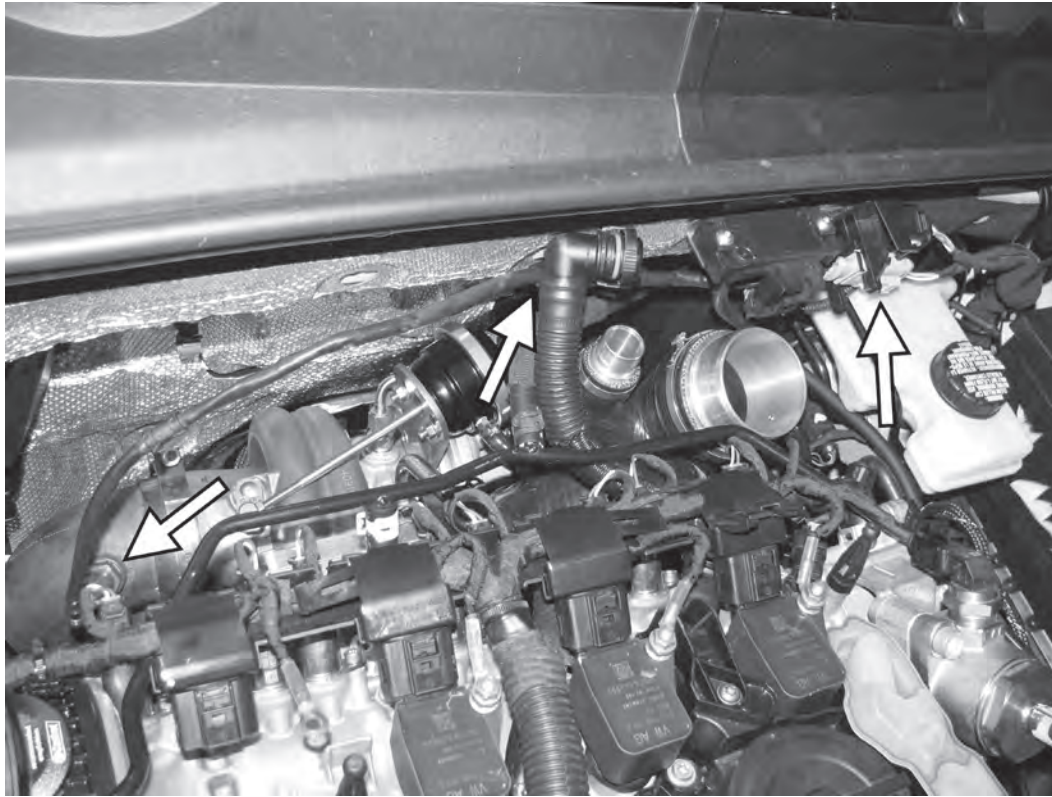

91) Install the previously removed primary oxygen sensor in the APR downpipe with an oxygen sensor socket. Tighten the oxygen sensor to 55Nm (41lb-ft). Route the harness to the left side of the firewall, reconnect the harness to the connector on the firewall, and install in its mounting bracket.

92) Mount the APR midpipe to the downpipe with the supplied sleeve clamp. Orient the midpipe so the oxygen sensor bung faces up and slightly to the left side of the car. Tighten the four 13mm nuts to 23Nm (17lb-ft) to secure in place. Tighten the 15mm bolt and nut holding the downpipe bracket to the downpipe.

NOTE: This midpipe can be purchased separately, and is the same midpipe included with an APR Stage 2 downpipe.



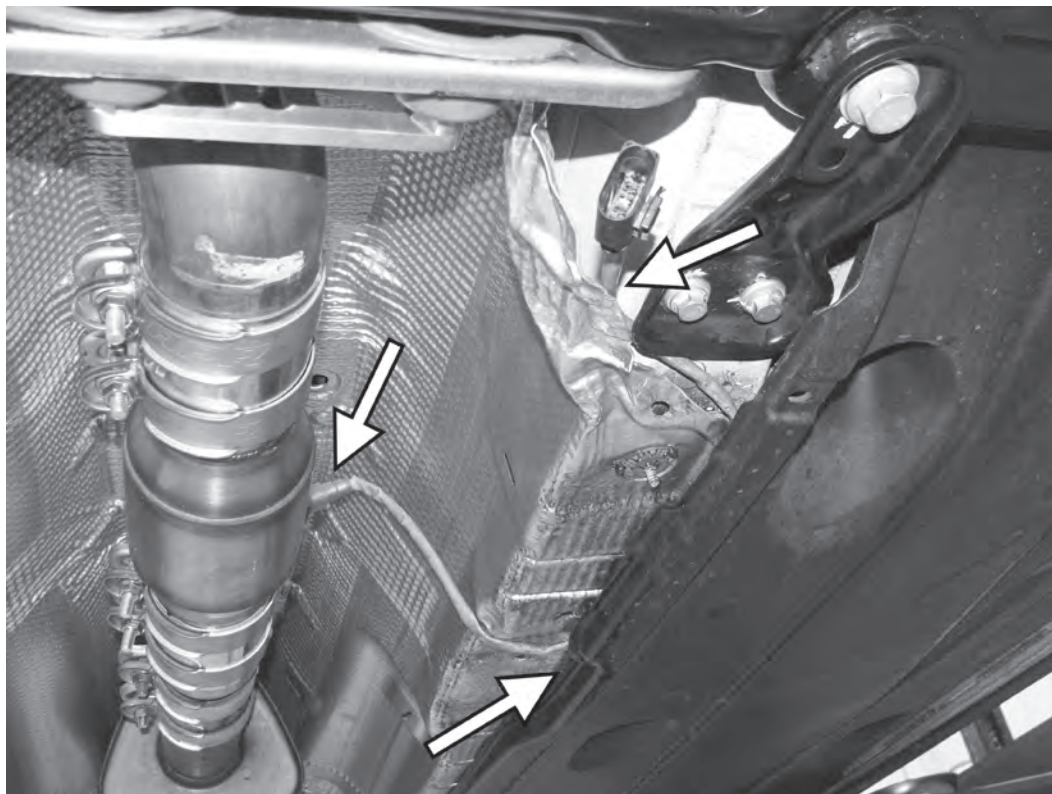

93) Mount the secondary oxygen sensor in the APR midpipe, and route the harness to the left side of the car. Tighten the oxygen sensor to 55Nm (41lb-ft). Tuck the harness underneath the plastic belly tray and to the front of the car, with the electrical connector coming out behind the center tunnel heat shielding.

94) Connect the APR 4 pin oxygen sensor extension harness to the factory harness on the firewall. Secure in the factory mounting bracket and route the APR harness down to the bottom of the car as shown.





95) Connect the APR extension harness to the secondary oxygen sensor connector. Fold and tuck any excess cabling behind the center tunnel heat shielding.

96) Move the primary oxygen sensor mounting clip on the heatshield to the right side of the heatshield as shown. Place the oxygen sensor harness in the clip and also in the cable mounting clip on the firewall. Tighten the included V-band clamp on the down-pipe to 17Nm (150in-lb).



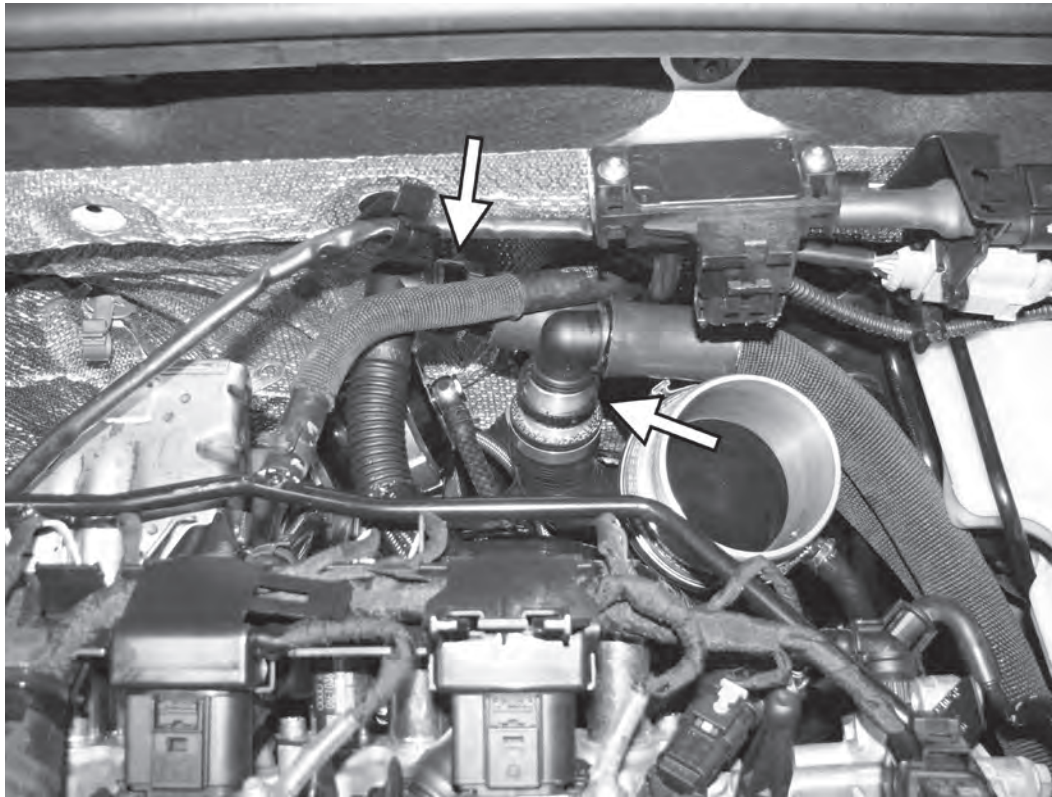

97) Connect the factory PCV vent line to the port on the APR turbo inlet hose. If using the APR catch can, connect the hoses to the port on the inlet hose and the factory PCV vent.

98) Place the APR intake back into the car, mounting the front of the intake into the mounting slot on the back of the radiator core support. Secure the left side of the intake with the original screw.



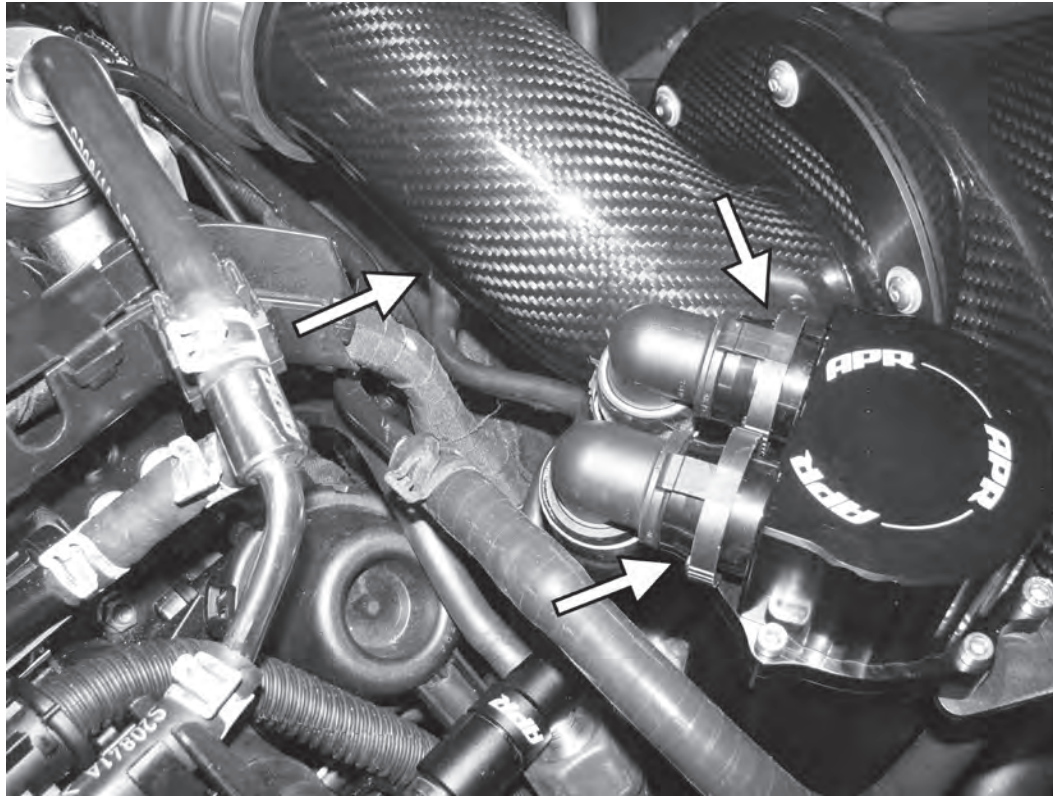

99) Connect the vacuum line to the port on the bottom of the intake. If equipped, connect the APR catch can hoses to the catch can.

100) Connect the coupler from the intake to the APR turbo inlet hose and secure with the original clamp.

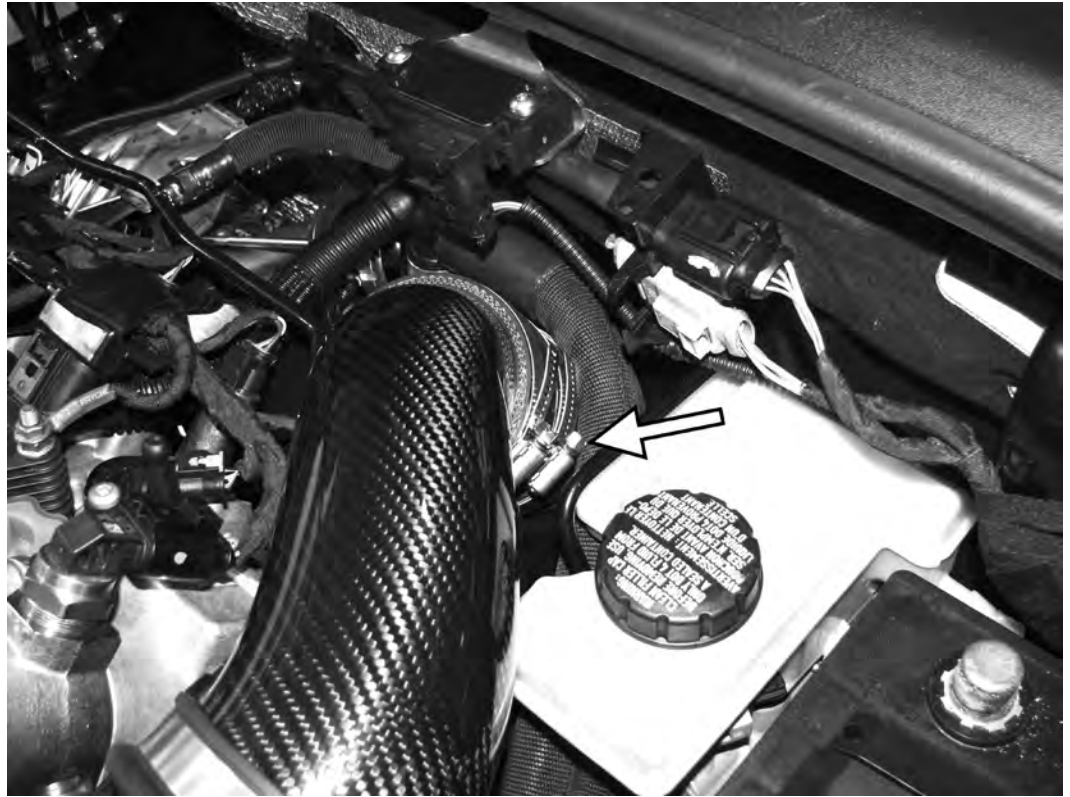

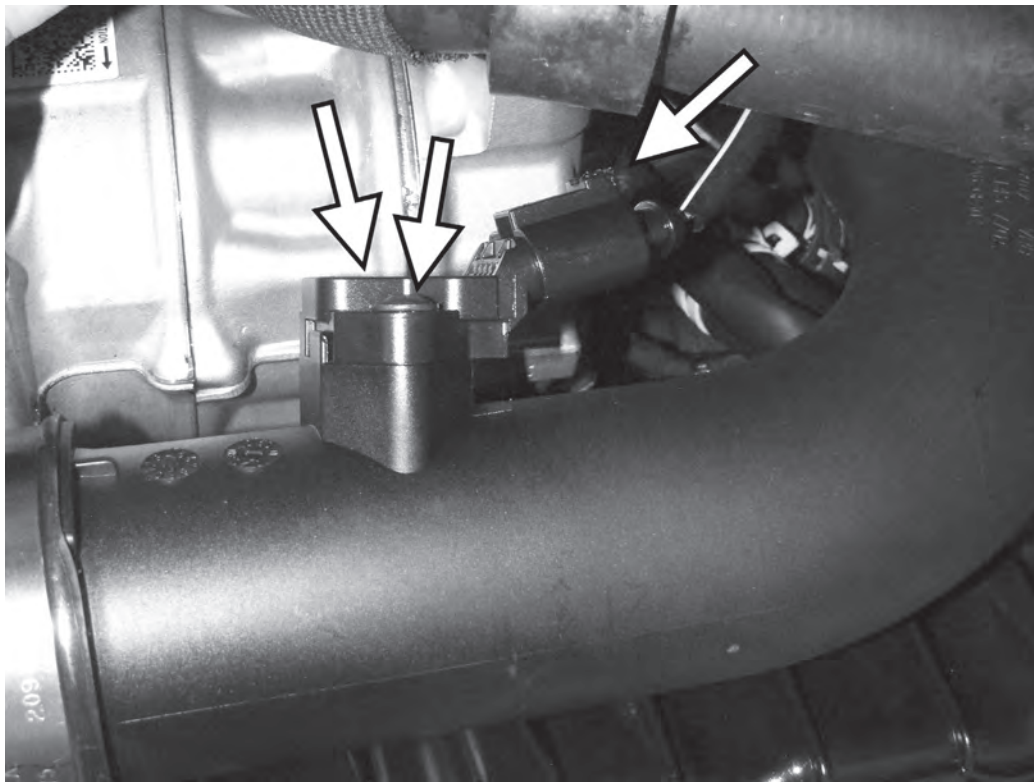

101) Underneath the front of the engine, disconnect the electrical connector to the TMAP sensor that is in the throttle body inlet pipe. Remove the two T20 screws holding the TMAP sensor in the pipe, and remove the TMAP sensor. Install the supplied TMAP sensor and secure with the two T20 screws. Finally, reconnect the electrical connector to the new TMAP sensor.

102) Fill the coolant reservoir with coolant. It is highly recommended that you use a vacuum-style coolant bleeding tool to get all air bubbles out of the cooling system.





103) Top off the engine with engine oil. It is highly recommended to do a full engine oil and filter change at this point.

104) Reinstall the engine belly pan, making sure the belly pan snaps into the lower portion of the front bumper cover as it did originally. Secure with the eight original T25 screws.

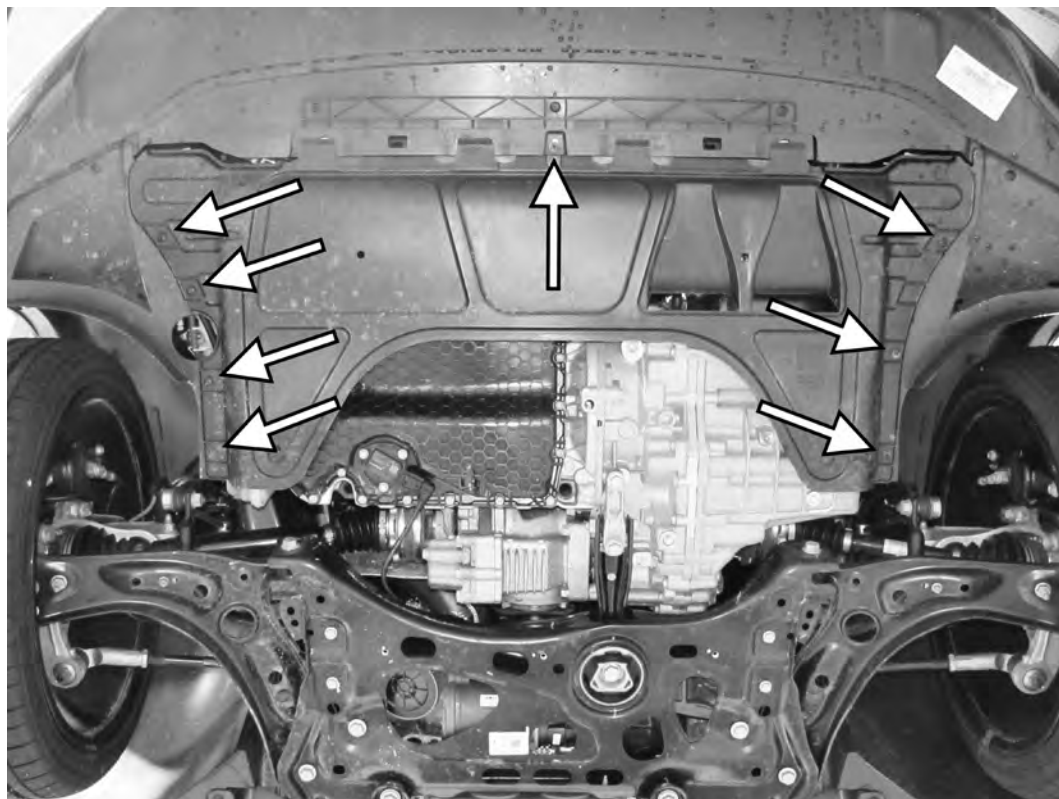

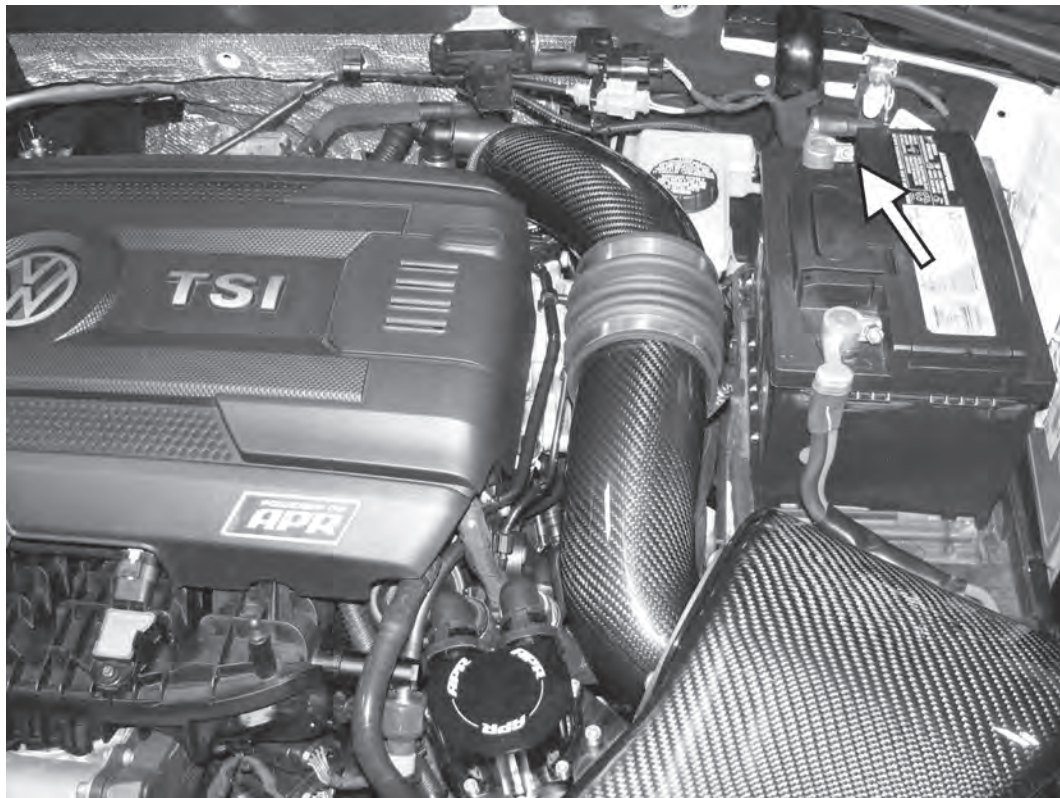

105) Reconnect the negative battery terminal and secure with the 10mm bolt. Reinstall the engine cover by snapping the cover in place.

Some important items to preform after installing:

- Boost leak check the car to 35psi, using a tool like the APR Boost Leak test tool. When checking for leaks, be sure to use water with a very high soap content (30-50% soap).
- Check all torque specs on boost hoses on the kit. All T-bolt clamps should be torqued to 50in-lbs (5.7Nm).
- Install the latest version software from the DPP webpage.

Sign: _____ Date: _____

Print: _____ APR Dealer: _____

On Stage 3+ cars with the fueling kit ONLY:

- Verify the low side fuel pressure. Using VAG-Com, go to Engine>Measuring blocks. With the engine off, check the measuring block labeled “Fuel low pressure; actual value”. The reading should be anything other than 0.0 bar and 100 bar(unplug the sensor and verify the max value). Then start the car and let it idle, the reading should be 5.0 bar +/- .5 bar.

Sign: _____ Date: _____

Print: _____ APR Dealer: _____

- Place signed manual in the customer vehicle.

02.23.17

#TL100108



APR

MOB STAGE III EFR TURBO SYSTEM
INSTALLATION INSTRUCTIONS